



Thermal Bi-spectrum Network Positioning System

User Manual

User Manual

COPYRIGHT ©2018 Hangzhou Hikvision Digital Technology Co., Ltd.

ALL RIGHTS RESERVED.

Any and all information, including, among others, wordings, pictures, graphs are the properties of Hangzhou Hikvision Digital Technology Co., Ltd. or its subsidiaries (hereinafter referred to be "Hikvision"). This user manual (hereinafter referred to be "the Manual") cannot be reproduced, changed, translated, or distributed, partially or wholly, by any means, without the prior written permission of Hikvision. Unless otherwise stipulated, Hikvision does not make any warranties, guarantees or representations, express or implied, regarding to the Manual.

About this Manual

This Manual is applicable to **Thermal Bi-spectrum Network Positioning System**.

The Manual includes instructions for using and managing the product. Pictures, charts, images and all other information hereinafter are for description and explanation only. The information contained in the Manual is subject to change, without notice, due to firmware updates or other reasons. Please find the latest version in the company website (<http://overseas.hikvision.com/en/>).

Please use this user manual under the guidance of professionals.

Trademarks Acknowledgement

HIKVISION and other Hikvision's trademarks and logos are the properties of Hikvision in various jurisdictions. Other trademarks and logos mentioned below are the properties of their respective owners.

Legal Disclaimer

TO THE MAXIMUM EXTENT PERMITTED BY APPLICABLE LAW, THE PRODUCT DESCRIBED, WITH ITS HARDWARE, SOFTWARE AND FIRMWARE, IS PROVIDED "AS IS", WITH ALL FAULTS AND ERRORS, AND HIKVISION MAKES NO WARRANTIES, EXPRESS OR IMPLIED, INCLUDING WITHOUT LIMITATION, MERCHANTABILITY, SATISFACTORY QUALITY, FITNESS FOR A PARTICULAR PURPOSE, AND NON-INFRINGEMENT OF THIRD PARTY. IN NO EVENT WILL HIKVISION, ITS DIRECTORS, OFFICERS, EMPLOYEES, OR AGENTS BE LIABLE TO YOU FOR ANY SPECIAL, CONSEQUENTIAL, INCIDENTAL, OR INDIRECT DAMAGES, INCLUDING, AMONG OTHERS, DAMAGES FOR LOSS OF BUSINESS PROFITS, BUSINESS INTERRUPTION, OR LOSS OF DATA OR DOCUMENTATION, IN CONNECTION WITH THE USE OF THIS PRODUCT, EVEN IF HIKVISION HAS BEEN ADVISED OF THE POSSIBILITY OF SUCH DAMAGES.

REGARDING TO THE PRODUCT WITH INTERNET ACCESS, THE USE OF PRODUCT SHALL BE WHOLLY AT YOUR OWN RISKS. HIKVISION SHALL NOT TAKE ANY RESPONSIBILITIES FOR ABNORMAL OPERATION, PRIVACY LEAKAGE OR OTHER DAMAGES RESULTING FROM CYBER ATTACK, HACKER ATTACK, VIRUS INSPECTION, OR OTHER INTERNET SECURITY RISKS; HOWEVER, HIKVISION WILL PROVIDE TIMELY TECHNICAL SUPPORT IF REQUIRED.

SURVEILLANCE LAWS VARY BY JURISDICTION. PLEASE CHECK ALL RELEVANT LAWS IN

YOUR JURISDICTION BEFORE USING THIS PRODUCT IN ORDER TO ENSURE THAT YOUR USE CONFORMS THE APPLICABLE LAW. HIKVISION SHALL NOT BE LIABLE IN THE EVENT THAT THIS PRODUCT IS USED WITH ILLEGITIMATE PURPOSES.

IN THE EVENT OF ANY CONFLICTS BETWEEN THIS MANUAL AND THE APPLICABLE LAW, THE LATER PREVAILS.

Regulatory Information

FCC Information

Please take attention that changes or modification not expressly approved by the party responsible for compliance could void the user's authority to operate the equipment.

FCC compliance: This equipment has been tested and found to comply with the limits for a digital device, pursuant to part 15 of the FCC Rules. These limits are designed to provide reasonable protection against harmful interference when the equipment is operated in a commercial environment. This equipment generates, uses, and can radiate radio frequency energy and, if not installed and used in accordance with the instruction manual, may cause harmful interference to radio communications. Operation of this equipment in a residential area is likely to cause harmful interference in which case the user will be required to correct the interference at his own expense.

FCC Conditions

This device complies with part 15 of the FCC Rules. Operation is subject to the following two conditions:

1. This device may not cause harmful interference.
2. This device must accept any interference received, including interference that may cause undesired operation.

EU Conformity Statement



This product and - if applicable - the supplied accessories too are marked with "CE" and comply therefore with the applicable harmonized European standards listed under the Low Voltage Directive 2006/95/EC, the EMC Directive 2014/30/EU, the RoHS Directive 2011/65/EU.



2012/19/EU (WEEE directive): Products marked with this symbol cannot be disposed of as unsorted municipal waste in the European Union. For proper recycling, return this product to your local supplier upon the purchase of equivalent new equipment, or dispose of it at designated collection points. For more information see: www.recyclethis.info.



2006/66/EC (battery directive): This product contains a battery that cannot be disposed of as unsorted municipal waste in the European Union. See the product documentation for specific battery information. The battery is marked with this symbol, which may include lettering to indicate cadmium (Cd), lead (Pb), or mercury (Hg). For proper recycling, return the battery to your supplier or to a designated collection point. For more information see: www.recyclethis.info.

Industry Canada ICES-003 Compliance

This device meets the CAN ICES-3 (A)/NMB-3(A) standards requirements.



Safety Instruction

These instructions are intended to ensure that the user can use the product correctly to avoid danger or property loss.

The precaution measure is divided into 'Warnings' and 'Cautions':

Warnings: Serious injury or death may be caused if any of these warnings are neglected.

Cautions: Injury or equipment damage may be caused if any of these cautions are neglected.

	
Warnings Follow these safeguards to prevent serious injury or death.	Cautions Follow these precautions to prevent potential injury or material damage.



Warnings

The device should be used in compliance with local laws and electrical safety regulations. Refer to the appropriate documentation for detailed information.

The input voltage should conform to IEC60950-1 standard: SELV (Safety Extra Low Voltage) and the Limited Power Source (24 VAC/12 VDC). Refer to the appropriate documentation for detailed information.

DO NOT connect multiple devices to one power adapter, to avoid over-heating or fire hazards caused by overload.

Make sure the plug is properly connected to the power socket.

If smoke, odor, or noise arises from the device, immediately turn off the power, unplug the power cable, and contact the service center.

The installer and user are responsible for password and security configuration and its settings.

Both internal and external grounds should be connected properly. (The cross section area of the grounding wire must be no less than 4 mm², and no less than that of the phase connector).



Cautions

Do not drop the device or subject it to physical shock.

Wipe the device gently with a clean cloth and a small quantity of ethanol, if necessary.

Do not aim the lens at the sun or any other bright light.

When any laser equipment is in use, make sure that the device lens is not exposed to the laser beam, or it may burn out.

Do not expose the device to high electromagnetic radiation or extremely hot, cold, dusty, or damp environments.

Place the device in a dry and well-ventilated environment.

Keep non-waterproof devices away from liquids.

Keep the device in original or similar packaging while transporting it.

A few device components (e.g., electrolytic capacitor) require regular replacement. The average lifespan varies, so periodic checking is recommended. Contact your dealer for details.

Improper use or replacement of the battery may result in explosion hazard. Replace with the same or equivalent type only. Dispose of used batteries in conformance with the instructions provided by the battery manufacturer.

Never attempt to disassemble the device.

0505401080709

Table of Contents

Chapter 1	Overview	1
1.1	Overview	1
1.2	System Requirement	1
1.3	Functions	1
Chapter 2	Network Connection	5
2.1	Setting the Network Positioning System over the LAN	5
2.1.1	<i>Wiring over the LAN</i>	5
2.1.2	<i>Activating the Positioning system</i>	6
2.2	Setting the Network Positioning system over the WAN	11
2.2.1	<i>Static IP Connection</i>	11
2.2.2	<i>Dynamic IP Connection</i>	12
Chapter 3	Access to the Network Positioning system	15
3.1	Accessing by Web Browsers	15
3.2	Accessing by Client Software	16
Chapter 4	Basic Operations	18
4.1	Configuring Local Parameters	18
4.2	Live View Page	20
4.3	Starting Live View	21
4.3.1	<i>Toolbar Description</i>	21
4.4	Operating PTZ Control	23
4.4.1	<i>PTZ Control Panel</i>	23
4.4.2	<i>Auxiliary Functions</i>	25
4.4.3	<i>Setting / Calling a Preset</i>	26
4.4.4	<i>Setting / Calling a Patrol</i>	29
4.4.5	<i>One-touch Patrol</i>	30
4.4.6	<i>Setting / Calling a Pattern</i>	31
4.5	Playback	32
4.5.1	<i>Play Back Video Files</i>	32
4.5.2	<i>Downloading Video Files</i>	35
4.6	Pictures	36
Chapter 5	System Configuration	38
5.1	Storage Settings	38
5.1.1	<i>Configuring Recording Schedule</i>	38
5.1.2	<i>Configuring Capture Schedule</i>	40
5.1.3	<i>Configuring Net HDD</i>	42
5.2	Event Configuration	44
5.2.1	<i>Configuring Motion Detection</i>	44
5.2.2	<i>Configuring Video Tampering Alarm</i>	49

5.2.3	Configuring Alarm Input	50
5.2.4	Configuring Alarm Output	52
5.2.5	Handling Exception	53
5.2.1	Detecting Audio Exception	53
5.3	Fire Source Detection Configuration	55
5.3.1	Configuring Initial Position	56
5.3.2	Configuring Dynamic Fire Source Detection	57
5.3.3	Configuring Fire Source Detection Shield	59
5.4	Temperature Measurement	61
5.4.1	Temperature Measurement Configuration	61
5.4.2	Configuring Temperature Measurement Rule	62
5.4.3	Linkage Method	67
5.4.4	Search History Temperature	67
5.4.5	VCA Rule Display	68
Chapter 6	VCA Configuration	69
6.1	Configuring VCA Information	69
6.2	Advanced Configuration	70
6.3	Behavior Analysis	71
6.4	Rule Configuration Demonstration	75
6.4.1	Line Crossing	75
6.4.2	Intrusion	77
6.4.3	Region Entrance	78
6.4.4	Region Exiting	78
Chapter 7	Positioning System Configuration	80
7.1	Configuring Network Settings	80
7.1.1	Basic Settings	80
7.1.2	Advanced Settings	86
7.2	Configuring Video and Audio Settings	96
7.2.1	Configuring Video Settings	96
7.2.2	Configuring Audio Settings	98
7.2.3	Configuring ROI Settings	99
7.3	PTZ Configuration	101
7.3.1	Configuring Basic PTZ Parameters	101
7.3.2	Configuring PTZ Limits	103
7.3.3	Configuring Park Actions	104
7.3.4	Configuring Privacy Mask	105
7.3.5	Configuring Scheduled Tasks	107
7.3.6	Clearing PTZ Configurations	108
7.3.7	Prioritize PTZ	108
7.3.8	Position and Vandal-Resistance Alarm Settings	109
7.3.9	Configuring Linear Scan	110
7.4	Configuring Image Settings	112
7.4.1	Configuring Display Settings	112

7.4.2	<i>Configuring OSD Settings</i>	121
7.4.3	<i>Configuring Text Overlay Settings</i>	122
7.4.4	<i>Configuring DPC Settings</i>	122
7.4.5	<i>Picture in Picture</i>	123
7.5	<i>Configuring System Settings</i>	124
7.5.1	<i>System Settings</i>	124
7.5.2	<i>Maintenance</i>	128
7.5.3	<i>Security</i>	133
7.5.4	<i>User Management</i>	135
Appendix	140
SADP Software Introduction	140

Chapter 1 Overview

1.1 Overview

Thermal bi-spectrum network positioning system (named as positioning system in the chapters below) integrates the function of the decoder, thermal camera, and the high-definition zoom camera. It performs temperature measurement, dynamic fire source detection and other smart detections in the remote surveillance of the power system, metallurgy system, and petrochemical engineering, and so on.

You can get a high-quality live view via web browser or client software.

The figure below shows one type of the positioning system series.

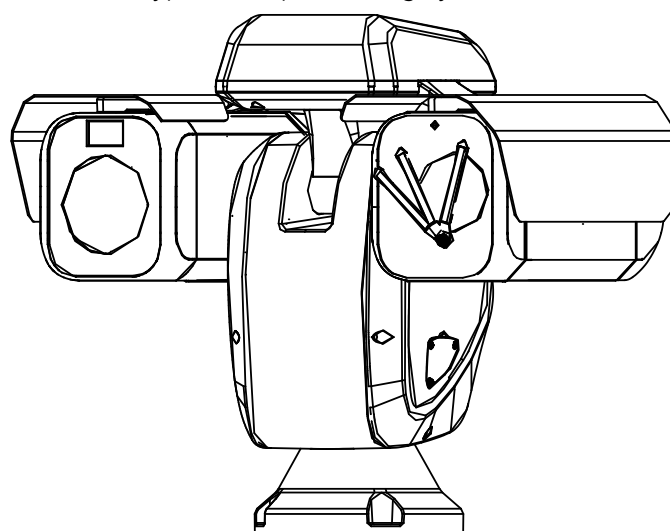

Figure 1-1 Overview of Thermal Positioning System

1.2 System Requirement

System requirement of web browser accessing is as follows:

Operating System: Microsoft Windows XP SP1 and above version / Vista / Win7 / Server 2003 / Server 2008 32bits

CPU: Intel Pentium IV 3.0 GHz or higher

RAM: 1G or higher

Display: 1024×768 resolution or higher

Web Browser: Internet Explorer 8.0 and above version, Apple Safari 5.02 and above version, Mozilla Firefox 5 and above version and Google Chrome 18 and above versions.

1.3 Functions

The main functions of this camera is fire source detection, and temperature measurement,

and VCA (video content analysis) functions.

Fire Detection

Fire Source Detection Shield enables you to shield certain areas from being detected in fire source detection.

For fire detection, refer to **Section 5.3 Fire Source Detection Configuration**

.

Temperature Measurement

When you enable this function, it measures the actual temperature of the spot being monitored. The device alarms when temperature exceeds the temperature threshold value.

For temperature measurement, refer to **Section 5.4 Temperature Measurement**.

VCA function

You can do intelligent analysis, such as behavior analysis. Multiple rules can be configured for different requirements.

For VCA function, refer to **Chapter 6**

VCA Configuration.

Alarm Input and Output

Refer to the figure below to configure the alarm devices and sensors.

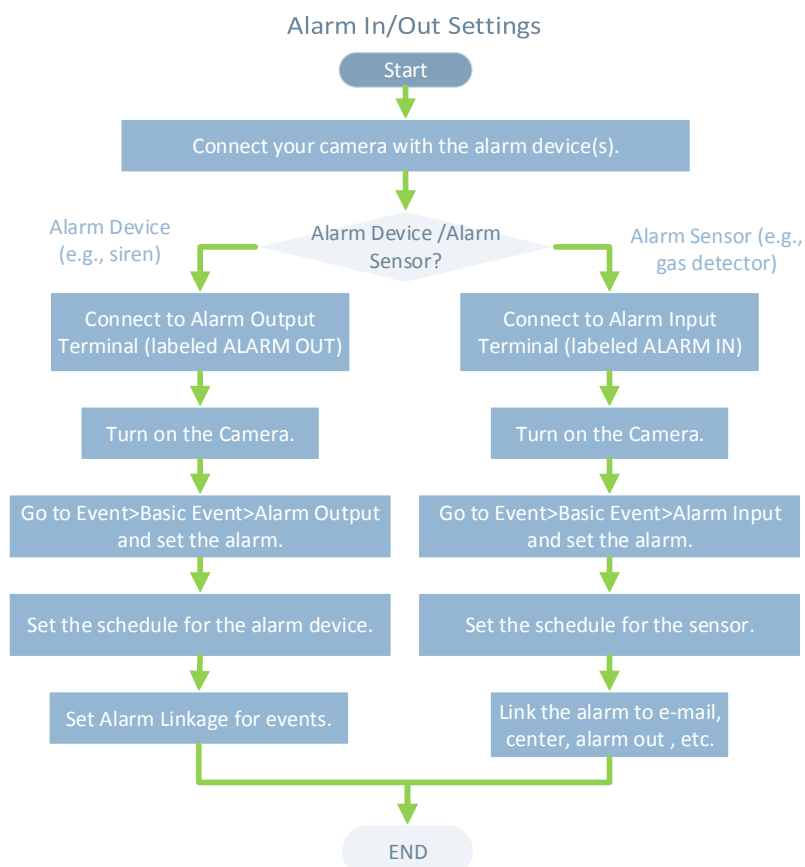

The functions vary depending on the models of positioning system.

Bi-spectrum

The positioning system has two lens, an optical one and a thermal one, and two images are respectively provided by each lens.

PTZ Limits

The positioning system can be programmed to move within the PTZ limits (left/right, up/down).

Scan Modes

The positioning system provides 5 scan modes: auto scan, tilt scan, frame scan, random scan and panorama scan.

Presets

A preset is a predefined image position. When the preset is called, the positioning system will automatically move to the defined position. The presets can be added, modified, deleted and called.

Label Display

The on-screen label of the preset title, azimuth/elevation, zoom, time and positioning system name can be displayed on the monitor. The displays of time and positioning

system name can be programmed.

Auto Flips

In manual tracking mode, when a target object goes directly beneath the positioning system, the video will automatically flip 180 degrees in horizontal direction to maintain continuity of tracking. This function can also be realized by auto mirror image depending on different camera models.

Privacy Mask

This function allows you to block or mask certain area of a scene, for preventing the personal privacy from recording or live viewing. A masked area will move with pan and tilt functions and automatically adjust in size as the lens zooms telephoto and wide.

3D Positioning

In the client software, use the left key of mouse to click on the desired position in the video image and drag a rectangle area in the lower right direction, then the positioning system will move the position to the center and allow the rectangle area to zoom in. Use the left key of mouse to drag a rectangle area in the upper left direction to move the position to the center and allow the rectangle area to zoom out.

Proportional Pan/Tilt

Proportional pan/tilt automatically reduces or increases the pan and tilt speeds according to the amount of zoom. At telephoto zoom settings, the pan and tilt speeds will be slower than at wide zoom settings. This keeps the image from moving too fast on the live view image when there is a large amount of zoom.

Auto Focus

The auto focus enables the camera to focus automatically to maintain clear video images.

Day/Night Auto Switch

The positioning systems deliver color images during the day. And as light diminishes at night, the positioning systems switch to night mode and deliver black and white images with high quality.

Slow Shutter

In slow shutter mode, the shutter speed will automatically slow down in low illumination conditions to maintain clear video images by extending the exposure time. The feature can be enabled or disabled.

Backlight Compensation (BLC)

If you focus on an object against strong backlight, the object will be too dark to be seen clearly. The BLC (Backlight Compensation) function can compensate light to the object in the front to make it clear, but this causes the over-exposure of the background where the light is strong.

Wide Dynamic Range (WDR)

The wide dynamic range (WDR) function helps the camera provide clear images even under back light circumstances. When there are both very bright and very dark areas simultaneously in the field of view, WDR balances the brightness level of the whole image and provide clear images with details.

White Balance (WB)

White balance can remove the unrealistic color casts. White balance is the white rendition function of the camera to adjust the color temperature according to the environment

automatically.

Patrol

A patrol is a memorized series of pre-defined preset function. The scanning speed between two presets and the dwell time at the preset are programmable.

Pattern

A pattern is a memorized series of pan, tilt, zoom, and preset functions. By default the focus and iris are in auto status during the pattern is being memorized.

Power Off Memory

The positioning system supports the power off memory capability with the predefined resume time. It allows the positioning system to resume its previous position after power is restored.

Scheduled Task

A time task is a preconfigured action that can be performed automatically at a specific date and time. The programmable actions include: auto scan, random scan, patrol 1-8 ,pattern 1-4, preset 1-8,frame scan, panorama scan, tilt scan, day, night, reboot, PT adjust, Aux Output, etc.

Park Action

This feature allows the positioning system to start a predefined action automatically after a period of inactivity.

3D Digital Noise Reduction

Comparing with the general 2D digital noise reduction, the 3D digital noise reduction function processes the noise between two frames besides processing the noise in one frame. The noise will be much less and the video will be clearer.

Chapter 2 Network Connection

Before you start:

If you want to set the network positioning system via a LAN (Local Area Network), please refer to **Section 2.1**.

If you want to set the network positioning system via a WAN (Wide Area Network), please refer to **Section 2.2**.

2.1 Setting the Network Positioning System over the LAN

Purpose:

To view and configure the positioning system via a LAN, you need to connect the network positioning system in the same subnet with your computer, and install the SADP or client software to search and change the IP of the network positioning system.



For the detailed introduction of SADP, please refer to Appendix.

2.1.1 Wiring over the LAN

The following figures show the two ways of cable connection of a network positioning system and a computer:

Purpose:

To test the network positioning system, you can directly connect the network positioning system to the computer with a network cable as shown in Figure 2-1.

Refer to the Figure 2-2 to set the network positioning system over the LAN via a switch or a router.

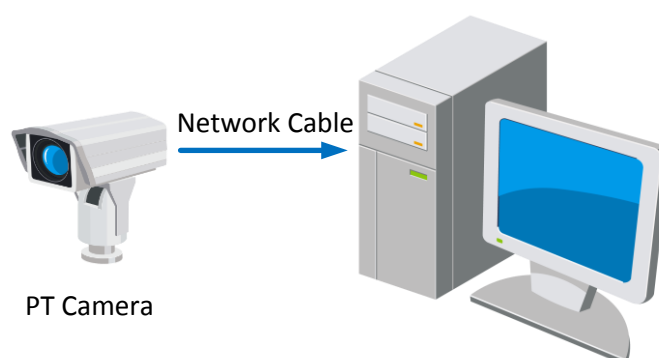

Figure 2-1 Connecting Directly

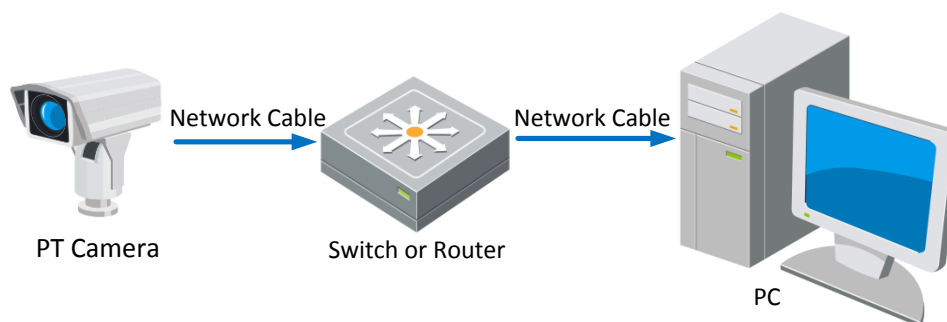

Figure 2-2 Connecting via a Switch or a Router

2.1.2 Activating the Positioning system

Purpose:

You are required to activate the positioning system first before you can use the positioning system.

Activation via Web Browser, Activation via SADP, and Activation via client software are supported. In the following sections, activation via web browser and SADP will be taken as examples. You may refer to the user manual of the positioning system for the details of activation via client software.

● Activation via Web Browser

Steps:

1. Power on the positioning system, and connect the positioning system to the network.
2. Input the IP address into the address bar of the web browser, and click **Enter** to enter the activation interface.



The default IP address of the positioning system is 192.168.1.64.

The screenshot shows a web-based activation interface. At the top, there is a title bar labeled 'Activation'. Below it, there are three input fields: 'User Name' with the value 'admin', 'Password' (empty), and 'Confirm' (empty). To the right of the 'Password' field, there is a text box containing the following text: 'Valid password range [8-16]. You can use a combination of numbers, lowercase, uppercase and special character for your password with at least two kinds of them contained.' At the bottom right of the form, there is an 'OK' button.

Figure 2-3 Activation Interface(Web)

3. Create a password and input the password into the password field.



STRONG PASSWORD RECOMMENDED—We highly recommend you create a strong password of your own choosing (Using a minimum of 8 characters, including at least three of the following categories: upper case letters, lower case letters, numbers, and special characters.) in order to increase the security of your product. And we recommend you reset your password regularly, especially in the high security system, resetting the password monthly or weekly can better protect your product.

4. Confirm the password.
5. Click **OK** to activate the positioning system and enter the live view interface.

● Activation via SADP Software

SADP software is used for detecting the online device, activating the device, and resetting the password.

Get the SADP software from the supplied disk or the official website, and install the SADP according to the prompts. Follow the steps to activate the positioning system.

Steps:

1. Run the SADP software to search the online devices.
2. Check the device status from the device list, and select an inactive device.

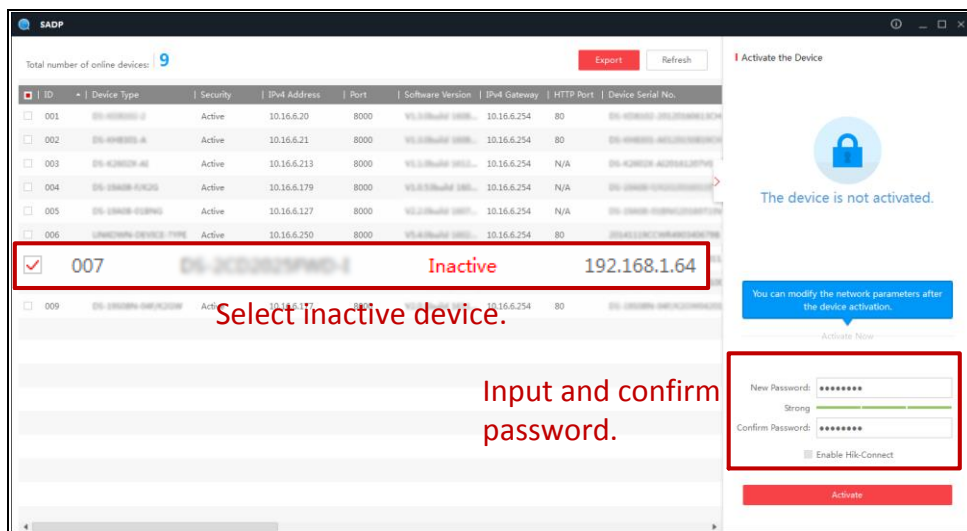

Figure 2-4 SADP Interface

3. Create a password and input the password in the password field, and confirm the password.



STRONG PASSWORD RECOMMENDED—We highly recommend you create a strong password of your own choosing (Using a minimum of 8 characters, including at least three of the following categories: upper case letters, lower case letters, numbers, and special characters.) in order to increase the security of your product. And we recommend you reset your password regularly, especially in the high security system, resetting the password monthly or weekly can better protect your product.

4. Click **OK** to save the password.

You can check whether the activation is completed on the popup window. If activation failed, please make sure that the password meets the requirement and then try again.

5. Change the device IP address to the same subnet with your computer by either modifying the IP address manually or checking the checkbox of **Enable DHCP**.

Modify Network Parameters

Enable DHCP
 Enable Hik-Connect

Device Serial No.: XX-XXXXXXXX-XXXXXXXXXXXXXXXX

IP Address: 192.168.1.64

Port: 8000

Subnet Mask: 255.255.255.0

Gateway: 192.168.1.1

IPv6 Address: ::

IPv6 Gateway: ::

IPv6 Prefix Length: 0

HTTP Port: 80

Security Verification

Admin Password:

[Forgot Password](#)

Modify

Figure 2-5 Modify the IP Address

6. Input the password and click **Save** to activate your IP address modification.

● Activation via Client Software

The client software is versatile video management software for multiple kinds of devices. Get the client software from the supplied disk or the official website, and install the software according to the prompts. Follow the steps to activate the camera.

Steps:

1. Run the client software and the control panel of the software pops up, as shown in the figure below.

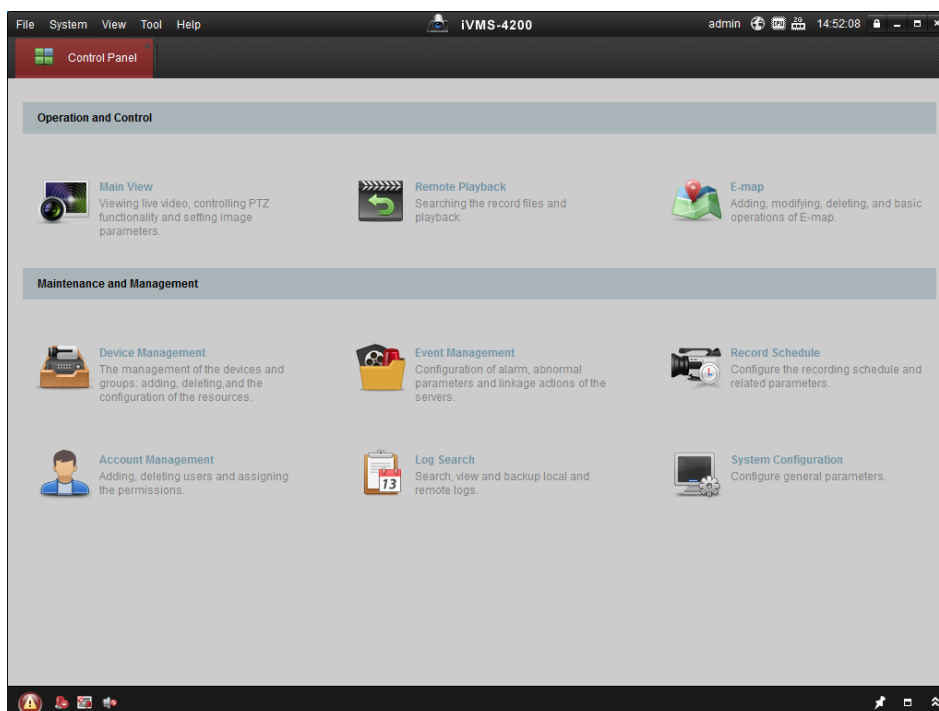

Figure 2-6 Control Panel

2. Click **Device Management** to enter the Device Management interface, as shown in the figure below.

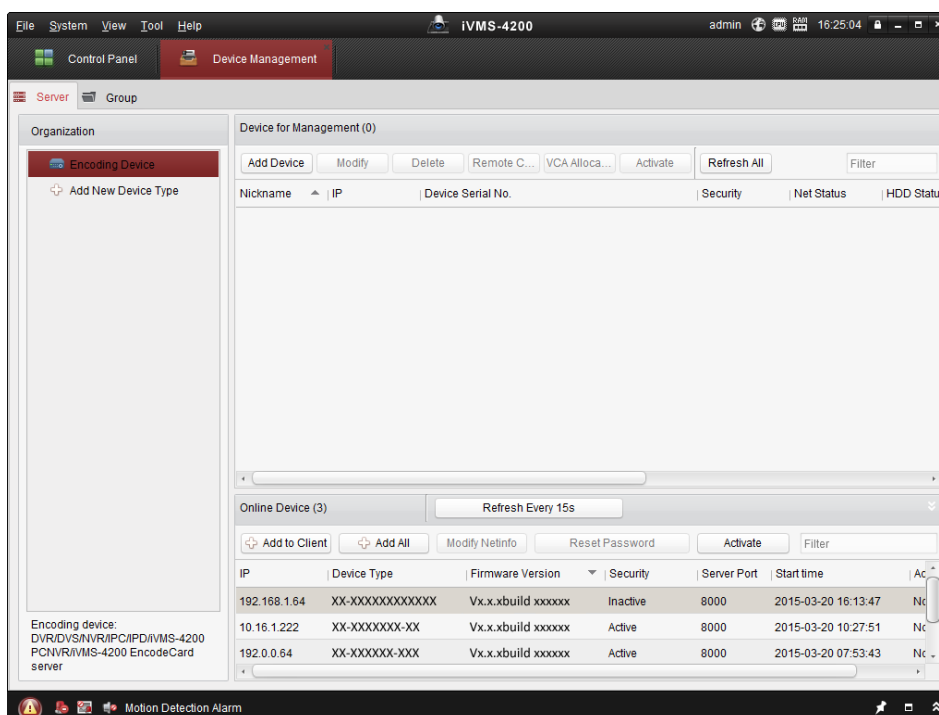

Figure 2-7 Device Management Interface

3. Check the device status from the device list, and select an inactive device.
4. Click **Activate** to pop up the Activation interface.
5. Create a password and input the password in the password field, and confirm the password.



STRONG PASSWORD RECOMMENDED—We highly recommend you create a strong password of your own choosing (Using a minimum of 8 characters, including at least three of the following categories: upper case letters, lower case letters, numbers, and special characters.) in order to increase the security of your product. And we recommend you reset your password regularly, especially in the high security system, resetting the password monthly or weekly can better protect your product.

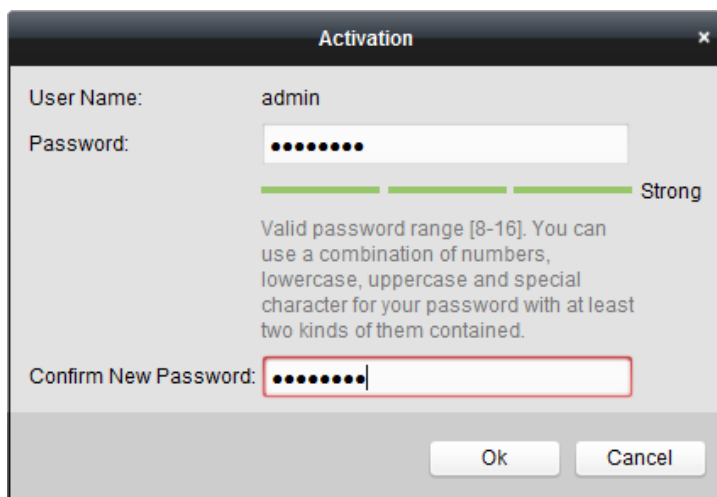

Figure 2-8 Activation Interface

- 6. Click **OK** to start activation.
- 7. Click **Modify Netinfo** to pop up the Network Parameter Modification interface, as shown in the figure below.

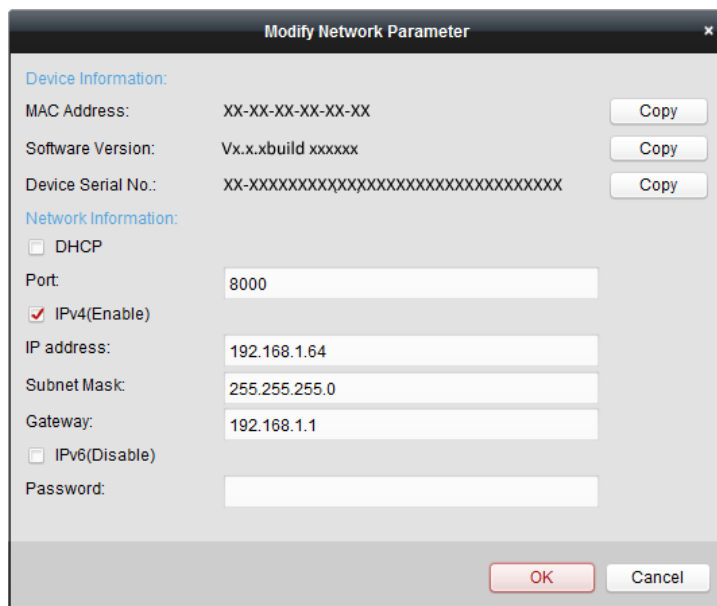

Figure 2-9 Modifying the Network Parameters

- 8. Change the device IP address to the same subnet with your computer by either modifying the IP address manually or checking the checkbox of **Enable DHCP**.
- 9. Input the password to activate your IP address modification.

2.2 Setting the Network Positioning system over the WAN

Purpose:

This section explains how to connect the network positioning system to the WAN with a static IP or a dynamic IP.

2.2.1 Static IP Connection

Before you start:

Please apply a static IP from an ISP (Internet Service Provider). With the static IP address, you can connect the network positioning system via a router or connect it to the WAN directly.

Connecting the network positioning system via a router

Steps:

1. Connect the network positioning system to the router.
2. Assign a LAN IP address, the subnet mask and the gateway. Refer to **Section 2.1.2** for detailed IP address configuration of the positioning system.
3. Save the static IP in the router.
4. Set port mapping, E.g., 80, 8000 and 554 ports. The steps for port mapping vary depending on different routers. Please call the router manufacturer for assistance with port mapping.
5. Visit the network positioning system through a web browser or the client software over the internet.

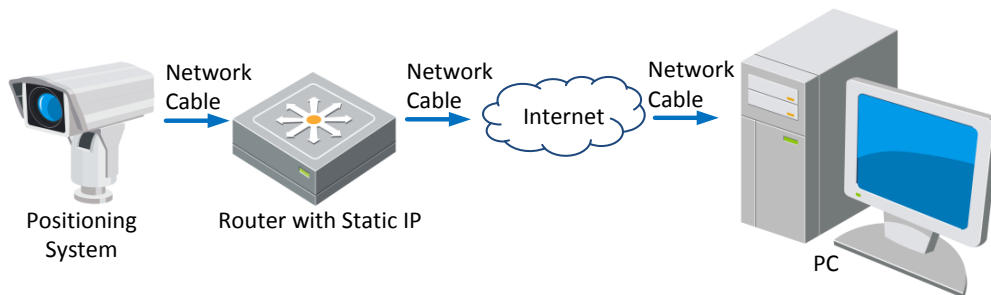

Figure 2-10 Accessing the Positioning system through Router with Static IP

Connecting the network positioning system with static IP directly

You can also save the static IP in the positioning system and directly connect it to the internet without using a router. Refer to **Section 2.1.2** for detailed IP address configuration of the positioning system.

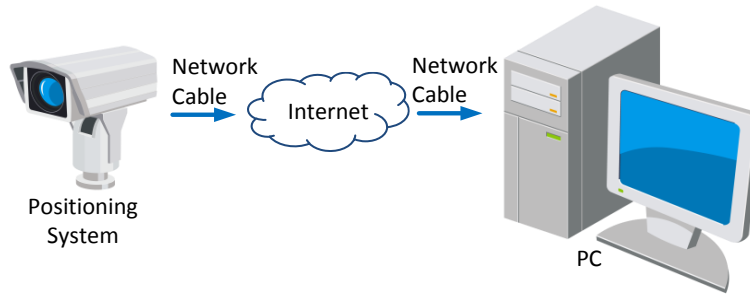

Figure 2-11 Accessing the Positioning system with Static IP Directly

2.2.2 Dynamic IP Connection

Before you start:

Please apply a dynamic IP from an ISP. With the dynamic IP address, you can connect the network positioning system to a modem or a router.

Connecting the network positioning system via a router

Steps:

1. Connect the network positioning system to the router.
2. In the positioning system, assign a LAN IP address, the subnet mask and the gateway. Refer to **Section 2.1.2** for detailed LAN configuration.
3. In the router, set the PPPoE user name, password and confirm the password.



For your privacy and to better protect your system against security risks, we strongly recommend the use of strong passwords for all functions and network devices. The password should be something of your own choosing (using a minimum of 8 characters, including upper case letters, lower case letters, numbers and special characters) in order to increase the security of your product.

Proper configuration of all passwords and other security settings is the responsibility of the installer and/or end-user.

4. Set port mapping. E.g. 80, 8000 and 554 ports. The steps for port mapping vary depending on different routers. Please call the router manufacturer for assistance with port mapping.
5. Apply a domain name from a domain name provider.
6. Configure the DDNS settings in the setting interface of the router.
7. Visit the positioning system via the applied domain name.

Connecting the network positioning system via a modem

Purpose:

This positioning system supports the PPPoE auto dial-up function. The positioning system gets a public IP address by ADSL dial-up after the positioning system is connected to a modem. You need to configure the PPPoE parameters of the network positioning system. Refer to **Section 7.1.1 Configuring PPPoE Settings** for detailed configuration.

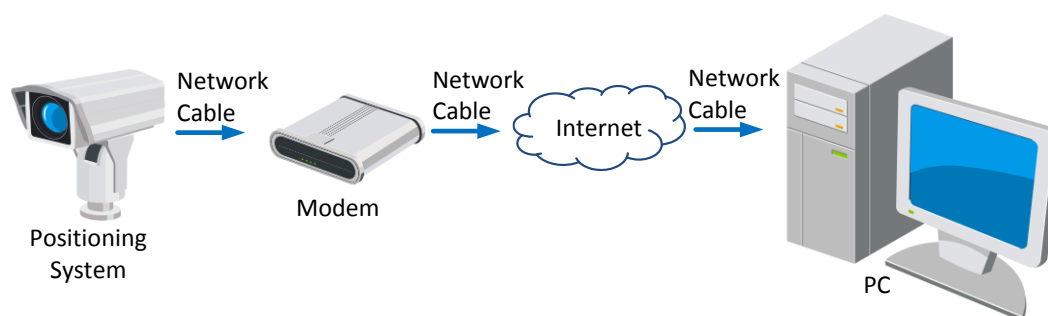

Figure 2-12 Accessing the Positioning system with Dynamic IP



The obtained IP address is dynamically assigned via PPPoE, so the IP address always changes after rebooting the positioning system. To solve the inconvenience of the dynamic IP, you need to get a domain name from the DDNS provider (E.g. DynDns.com). Please follow below steps for normal domain name resolution and private domain name resolution to solve the problem.

Normal Domain Name Resolution

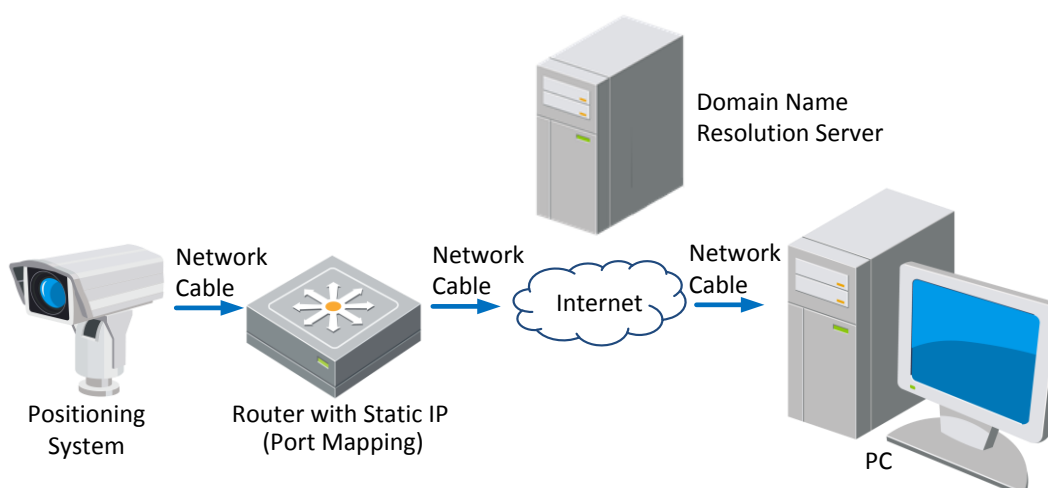

Figure 2-13 Normal Domain Name Resolution

Steps:

1. Apply a domain name from a domain name provider.
2. Configure the DDNS settings in the **DDNS Settings** interface of the network positioning system. Refer to **Section 7.1.1 Configuring DDNS Settings** for detailed configuration.
3. Visit the positioning system via the applied domain name.

Private Domain Name Resolution

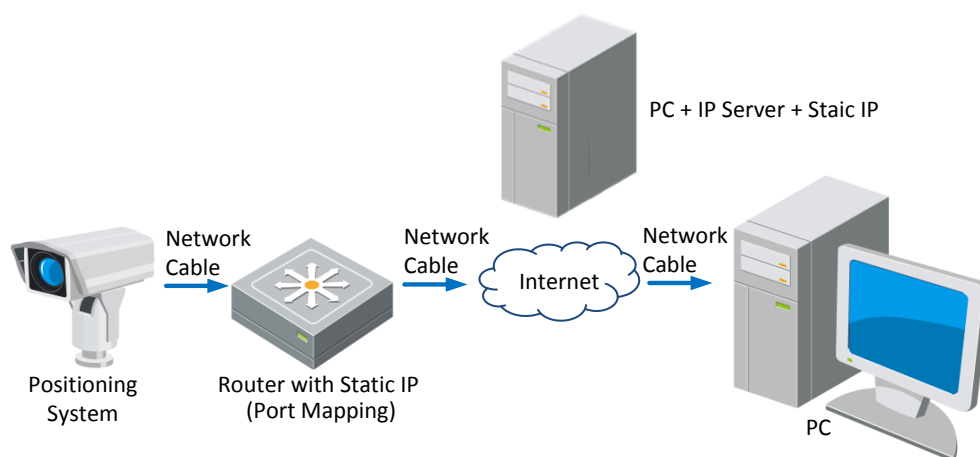

Figure 2-14 Private Domain Name Resolution

Steps:

1. Install and run the IP Server software in a computer with a static IP.
2. Access the network positioning system through the LAN with a web browser or the client software.
3. Enable DDNS and select IP Server as the protocol type. Refer to **Section 7.1.1 Configuring DDNS Settings** for detailed configuration.

Chapter 3 Access to the Network Positioning system

3.1 Accessing by Web Browsers

Steps:

1. Open the web browser.
2. In the address field, input the IP address of the network positioning system, e.g., 192.168.1.64 and press the **Enter** key to enter the login interface.
3. Activate the positioning system for the first time using, refer to the **section 2.1.2 Activating the Positioning system**.
4. Select English as the interface language on the top-right of login interface.
5. Input the user name and password and click .

The admin user should configure the device accounts and user/operator permissions properly. Delete the unnecessary accounts and user/operator permissions.



The device IP address gets locked if the admin user performs 7 failed password attempts (5 attempts for the user/operator).



Figure 3-1 Login Interface

6. Install the plug-in before viewing the live video and operating the positioning system. Please follow the installation prompts to install the plug-in.



You may have to close the web browser to install the plug-in. Please reopen the web browser and log in again after installing the plug-in.

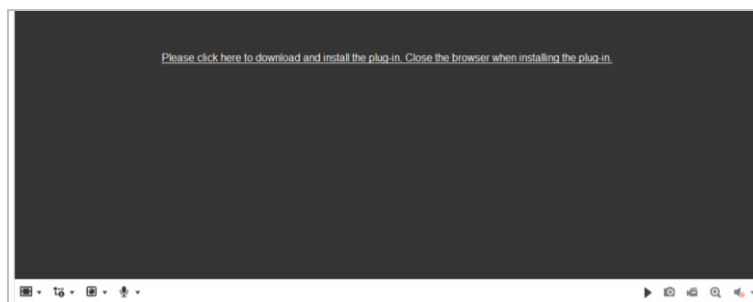

Figure 3-2 Download and Install Plug-in

3.2 Accessing by Client Software

The product CD contains the client software. You can view the live video and manage the positioning system with the client software.

Follow the installation prompts to install the client software and WinPcap. The configuration interface and live view interface of client software are shown below.

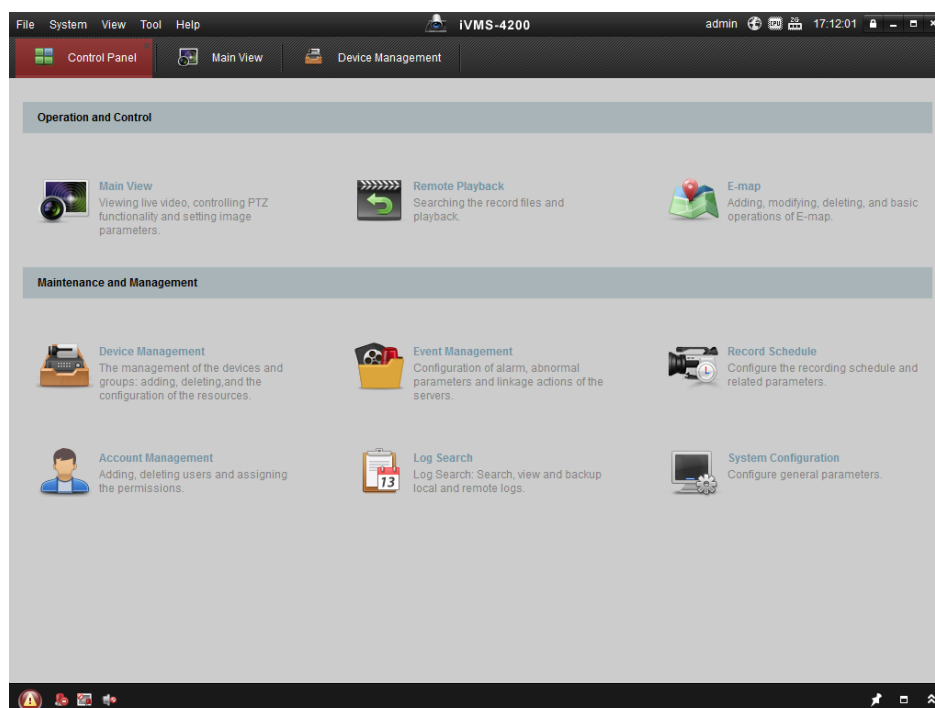

Figure 3-3 iVMS-4200 Control Panel

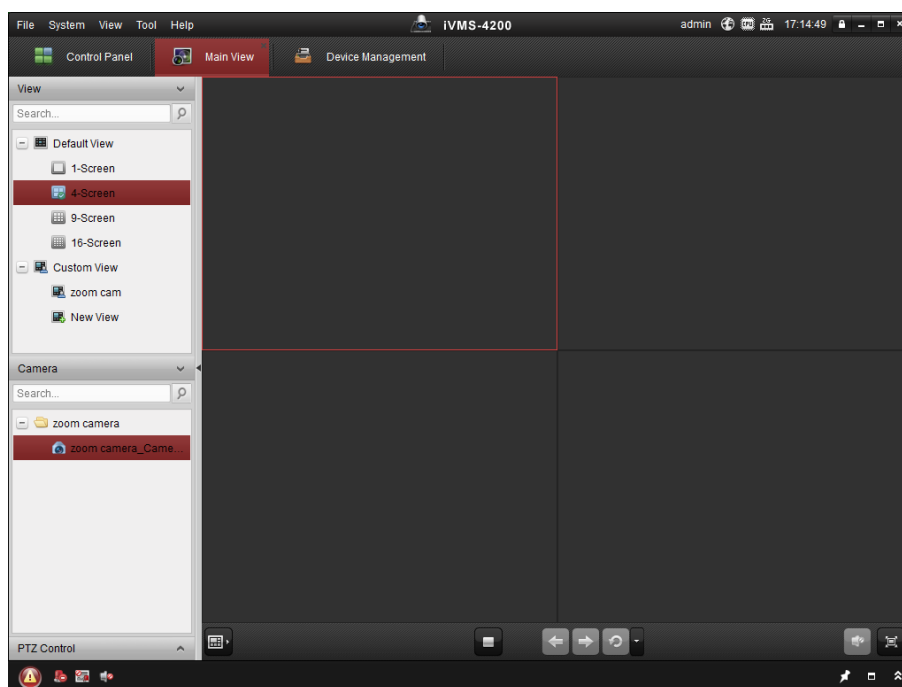

Figure 3-4 iVMS-4200 Live View Interface



If you use third party VMS software, please contact technical support of our branch for camera firmware.

For detailed information about client software of our company, please refer to the user manual of the software. This manual mainly introduces accessing to the network positioning system by web browser.

Chapter 4 Basic Operations

In this and the following chapters, operation of the positioning system by the web browser will be taken as an example.

4.1 Configuring Local Parameters



The local configuration refers to the parameters of the live view and other operations using the web browser.

Steps:

1. Enter the Local Configuration interface:

Configuration > Local

The screenshot displays the Local Configuration interface, which is organized into three main sections:

- Live View Parameters:** This section contains radio button options for Protocol (TCP, UDP, MULTICAST, HTTP), Play Performance (Shortest Delay, Balanced, Fluent), Rules (Enable, Disable), Auto Start Live View (Yes, No), Image Format (JPEG, BMP), and Fire Point (Locate Highest Te..., Frame Fire Point).
- Record File Settings:** This section includes radio button options for Record File Size (256M, 512M, 1G) and text input fields for Save record files to, Save downloaded files to, Save snapshots in live view to, Save snapshots when playback to, and Save clips to. Each text field is accompanied by 'Browse' and 'Open' buttons.
- Picture and Clip Settings:** This section contains text input fields for Save snapshots in live view to, Save snapshots when playback to, and Save clips to, each with 'Browse' and 'Open' buttons.

Figure 4-1 Local Configuration Interface

2. Configure the following settings:

Live View Parameters: Set the protocol type, play performance, rules and image

format.

Protocol Type: TCP, UDP, MULTICAST and HTTP are selectable.

TCP: Ensures complete delivery of streaming data and better video quality, yet the real-time transmission will be affected.

UDP: Provides real-time audio and video streams.

MULTICAST: It's recommended to select the protocol type to **MULTICAST** when using the Multicast function.

HTTP: Allows the same quality as of TCP without setting specific ports for streaming under some network environments.

Play Performance: Set the play performance to Shortest Delay, or Auto.

Rules: It refers to the rules on your local browser, select enable or disable to display or not display the colored marks when the motion detection, fire detection, or intrusion detection is triggered. E.g., enabled as the rules are, and the fire detection is enabled as well, when a fire is detected, it will be marked with a green rectangle on the live view.

Image Format: The captured pictures can be saved as different format. JPEG and BMP are available.

Fire Point: Locate Highest Temperature Point, and Frame Fire Point are selectable. Display the highest temperature area as point or frame.

Display Temperature Info.: Display temperature information or not with temperature measurement rule configured.

Display Temperature Info. on Capture: Display temperature information on the capture or not.

Record File Settings: Set the saving path of the video files.

Record File Size: Select the packed size of manually recorded and downloaded video files. The size can be set to 256M, 512M or 1G.

Save record files to: Set the saving path for the manually recorded video files.

Save downloaded files to: Set the saving path for the downloaded video files in

Playback

interface.

Picture and Clip Settings: Set the saving paths of the captured pictures and clipped video files.

Save snapshots in live view to: Set the saving path of the manually captured pictures in **Live View** interface.

Save snapshots when playback to: Set the saving path of the captured pictures in **Playback** interface.

Save clips to: Set the saving path of the clipped video files in **Playback** interface.



You can click **Browse** to change the directory for saving video files, clips and

pictures.

You can click **Open** to directly open the video files, clips and pictures.

3. Click  to save the settings.

4.2 Live View Page

Purpose:

The live video page allows you to view live video, capture images, realize PTZ control, set/call presets and configure video parameters.

Log in the network positioning system to enter the live view page, or you can click

 on the menu bar of the main page to enter the live view page.

Descriptions of the live view page:

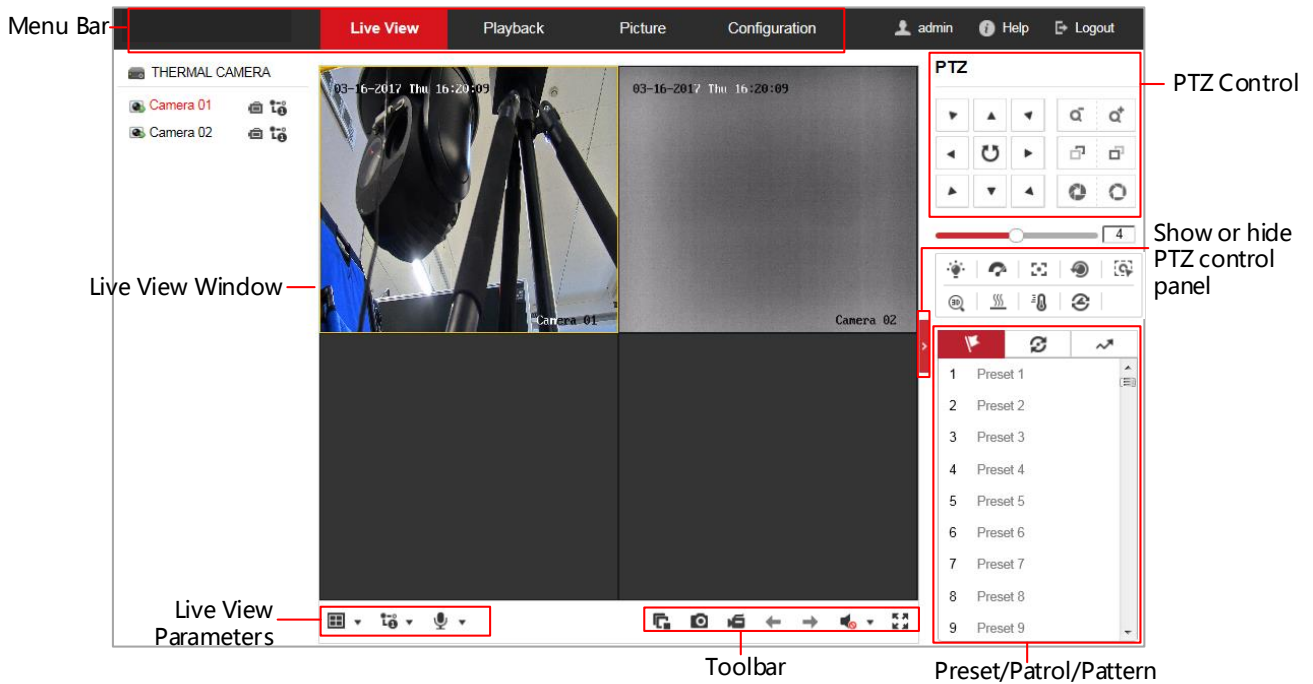

Figure 4-2 Live View Page

Menu Bar:

Click each tab to enter Live View, Playback, Picture, and Configuration page respectively.

Click  to display the help file of the positioning system.

Click  to logout the system.

Live View Window:

Display the live video.

Toolbar:

Operations on the live view page, e.g., live view, capture, record, audio on/off, regional exposure, regional focus, etc.

PTZ Control:

Panning, tilting, focusing and zooming actions of the positioning system. The lighter, wiper, one-touch focus and lens initialization control.

Preset/patrol/pattern:

Set and call the preset/patrol/pattern for the positioning system.



Pattern function varies depending on the models of positioning system.

Live View Parameters:

Configure the image size, stream type, plug-in type, and two-way audio of the live video.

4.3 Starting Live View



In the live view window as shown in Figure 4-3, click  on the toolbar to start the live view of the positioning system.



Figure 4-3 Start Live View

4.3.1 Toolbar Description

Table 4-1 Descriptions of the Toolbar

Icon	Description	Icon	Description
	Start/Stop Live view.		Manually capture the pictures.

	Display in 1×1/2×2/3×3/4×4 window.		Live view with the main/sub stream.
	Manual start/stop recording.		Start/Stop Two-way Audio.
	View previous / next page.		Mute/Audio on and adjust volume
	Show full screen		

Double-click on the live video to switch the current live view into full-screen or return to normal mode from the full-screen.

Click and it displays . Click to enable two-way audio and the icon turns into . Click the icon again to stop two-way audio.

Click to select from and display live video in 1 × 1/2 × 2/3 × 3/4 × 4 window.

Click to select from and display live video with the main/ sub stream. The main stream is with a relatively high resolution and needs much bandwidth. The default setting of stream type is .

Click and it displays . Click to enable two-way audio and the icon turns into . Click the icon again to stop two-way audio.

Click to start live view and the icon turns into . Click the icon again to stop live view.

Click to capture the picture.

Click to start recording and the icon turns into . Click the icon again to stop recording.

Click to switch between the optical channel and thermal channel when selecting 1 × 1 live view window.

Click to display the . Drag the slider to adjust the volume.

Click to show full screen of live view, press Esc to exit.



Before using the two-way audio or recording with audio functions, please set the **Stream Type** to **Video & Audio** referring to **Section 7.2.1 Configuring Video Settings**.

Please refer to the following sections for more information:

Configuring remote recording in **Section 5.1.1 Configuring Recording Schedule**.

Setting the image quality of the live video in **Section 7.4 Configuring Image Settings** and **Section 7.2.1 Configuring Video Settings**.



Setting the OSD text on live video in **Section 7.4.2 Configuring OSD Settings**.

4.4 Operating PTZ Control

Purpose:

In the live view interface, you can use the PTZ control buttons to control panning, tilting and zooming.

4.4.1 PTZ Control Panel

On the live view page, click  to show the PTZ control panel or click  to hide it. Click the direction buttons to control the pan/tilt movements. Click the zoom/iris/focus buttons to realize lens control.

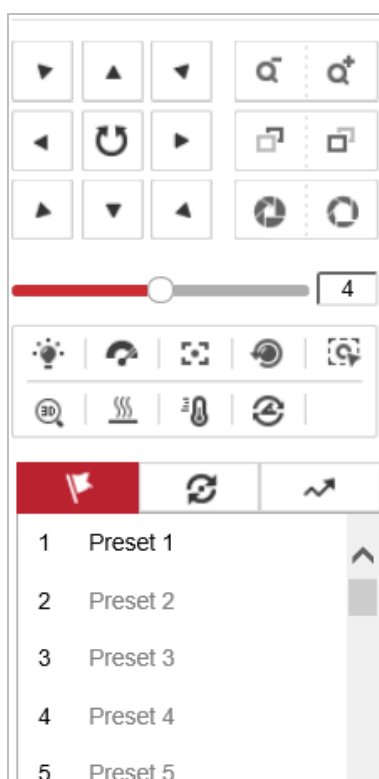



















Figure 4-4 PTZ Control Panel

Table 4-2 Descriptions of PTZ Control Panel





Button	Name	Description
--------	------	-------------

Button	Name	Description
	PTZ Control Panel	Hold and press the direction button to pan/tilt the positioning system. Click  and the positioning system keeps panning, the icon turns into  . Click the icon again to stop the positioning system.
	Zoom out/in	Click  , the lens zooms in, click  , and the lens zooms out.
	Focus near/far	Click  , the lens focus far and the items far away gets clear. Click  , the lens focus near and the items nearby gets clear.
	Iris close/open	When the image is too dark, click  to open the iris. When the image is too bright, click  to close the iris.
	Auxiliary Functions	The auxiliary functions include light, wiper, auxiliary focus, lens initialization, manual tracking, 3D positioning, de-icing heater, click-to-thermometry, synchronize FOV
	Speed Adjustment	Adjust speed of pan/tilt movements.
	Preset	Refer to 4.4.3 for detailed information of setting preset.
	Patrol	Refer to 4.4.4 for detailed information of setting patrol.
	Pattern	Refer to 4.4.6 for detailed information of setting pattern.

Buttons on the Preset/Patrol/Patterns interface:

Table 4-3 Descriptions of Buttons

Buttons	Description
	Start the selected patrol/pattern.

	Stop current patrol/pattern.
	Set the selected preset/patrol.
	Delete the selected preset/patrol/pattern.
	Start recording a pattern.
	Stop recording the pattern.

4.4.2 Auxiliary Functions

The Auxiliary functions panel is shown in the figure below:



Figure 4-5 Auxiliary Functions

 Light

Click  to enable/disable the light supplement of the positioning system. This function is reserved.

 Wiper

Click  to move the wiper once.

 Auxiliary Focus

The auxiliary focus function is reserved.



Click  and the lens operates the movements for initialization.



Click  to enable manual De-Icing function of the device.



The de-icing function takes effect when the device inner temperature is $\leq 30^{\circ}\text{C}$ (86°F).



Click  to enable/disable the manual thermometry function of the device. You can click any position on the interface to show the real temperature.



Click  to synchronize the FOV of optical lens and thermal lens

 Manual Tracking

Before you start:

Go to **Configuration > System > Maintenance > VCA Resource Type** and select the VCA

Resource as **Temperature Measurement + Behavior Analysis**.

Then enter the VCA Information Configuration interface:

Configuration > VCA Configuration > VCA Info and enable Intelligent Analysis first.

Steps:

1. Click  on the toolbar of live view interface.
2. Click a moving object in the live video.
The positioning system will track the object automatically.

 3D Positioning

Steps:

1. Click  on the toolbar of live view interface.
2. Operate the 3D positioning function:
3. Click a position of the live video. The corresponding position will be moved to the center of the live video.
4. Hold down the left mouse button and drag the mouse to the lower right on the live video. The corresponding position will be moved to the center of the live video and zoomed in.
5. Hold down the left mouse button and drag the mouse to the upper left on the live video. The corresponding position will be moved to the center of the live video and zoomed out.

 One-touch Patrol

Click  to call one-touch patrol. For detailed information of setting one-touch patrol, refer to **4.4.5 One-touch Patrol**.

 One-touch Park

Click  to save the current view as the preset No. 32 and start park at the the current position. This function is reserved.

4.4.3 Setting / Calling a Preset

Purpose:

A preset is a predefined image position. For the defined preset, you can click the calling button to quickly view the desired image position.

Setting a Preset:

Steps:

1. In the PTZ control panel, select a preset number from the preset list.

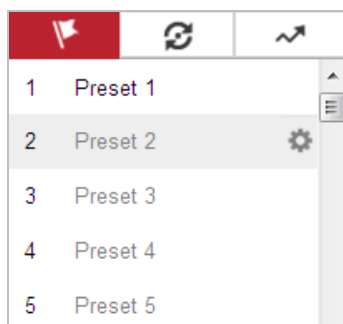





Figure 4-6 Setting a Preset

2. Use the PTZ control buttons to move the lens to the desired position.
 - Pan the positioning system to the right or left.
 - Tilt the positioning system up or down.
 - Zoom in or out.
 - Refocus the lens.
3. Click  to finish the setting of the current preset.
4. Edit a preset name by double clicking on the default name such as preset 1. (The pre-defined presets are named already and not configurable. Please refer to the user manual for detailed function description.)
5. You can click  to delete the preset.



You can configure up to 256 presets.

Calling a Preset:

In the PTZ control panel, select a defined preset from the list and click  to call the preset.

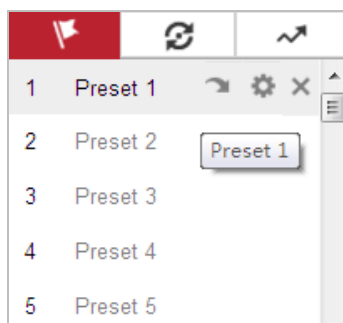

Figure 4-7 Calling a Preset

For convenient preset selection, refer to the following steps to navigate to the preset you want.

Steps:

1. Select any preset from the list.
2. Click the preset number you need on the keyboard.



The following presets are predefined with special commands. You can only call them but not configure them. For instance, preset 99 is the “Start auto scan”. If you call the

preset 99, the positioning system starts auto scan function.

Pattern function varies depending on the models of positioning system.

Table 4-4 Special Presets

Preset	Function	Preset	Function
33	Auto flip	92	Start to set limit stops
34	Back to initial position	93	Set limit stops manually
35	Call patrol 1	94	Remote reboot
36	Call patrol 2	95	Call OSD menu
37	Call patrol 3	96	Stop a scan
38	Call patrol 4	97	Start random scan
39	Day mode (IR cut filter in)	98	Start frame scan
40	Night mode (IR cut filter out)	99	Start auto scan
41	Call pattern 1	100	Start tilt scan
42	Call pattern 2	101	Start panorama scan
43	Call pattern 3	102	Call patrol 5
44	Call pattern 4	103	Call patrol 6
45	One-touch Patrol	104	Call patrol 7
90	Wiper	105	Call patrol 8

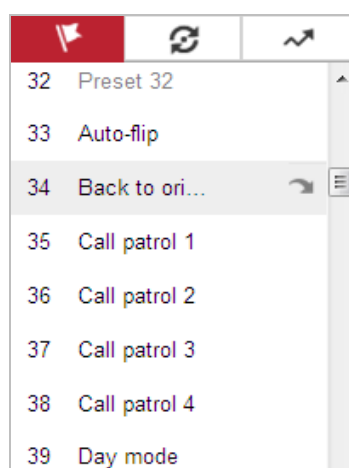

Figure 4-8 Special Preset



You may need to use the OSD (On Screen Display) menu when controlling the positioning system remotely. To display the OSD menu on the live view screen, you can call the preset number 95.

4.4.4 Setting / Calling a Patrol

Purpose:

A patrol is a memorized series of preset function. It can be configured and called on the patrol settings interface. There are up to 8 patrols for customizing. A patrol can be configured with 32 presets.

Before you start:

Please make sure that the presets you want to add into a patrol have been defined.

Setting a Patrol:

Steps:



1. In the PTZ control panel, click  to enter the patrol settings interface.
2. Select a patrol number from the list and click .
3. Click  to enter the adding interface of preset, as shown in Figure 4-9.



Figure 4-9 Adding Presets

4. Configure the preset number, patrol time and patrol speed.

Name	Description
Patrol Time	It is the duration staying on one patrol point. The positioning system moves to another patrol point after the patrol time.
Patrol Speed	It is the speed of moving from one preset to another.

5. Click **OK** to save a preset into the patrol.
6. Repeat the steps from 3 to 5 to add more presets.
7. Click **OK** to save all the patrol settings.

Calling a Patrol:

In the PTZ control panel, select a defined patrol from the list and click  to call the patrol, as shown in Figure 4-10.

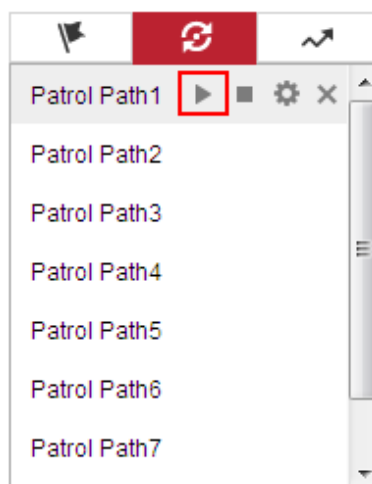



Figure 4-10 Calling a Preset

4.4.5 One-touch Patrol

Purpose:

One-touch patrol is an automatically created patrol. The system automatically add preset No.1 to No.32 to the patrol path 8. You can call the one-touch patrol and the positioning system moves as the patrol path 8 automatically.

Steps:

1. Set preset No.1 to No.32. Refer to **4.4.3 Setting / Calling a Preset** for detailed information of setting preset.
2. Call preset No. 45, and the positioning system moves as patrol path 8.
3. Click  to enter the patrol settings interface and start/stop one-touch patrol, edit the patrol time and the speed.
4. You can click  of the PTZ control panel to start one-touch patrol.

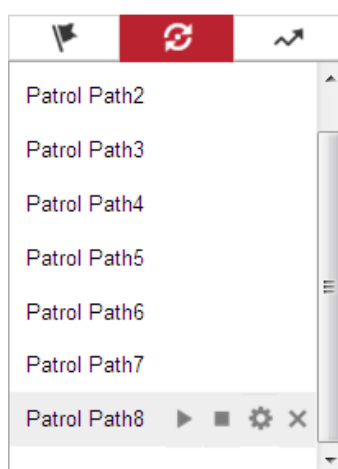

Figure 4-11 Patrol Path 8

4.4.6 Setting / Calling a Pattern

Purpose:

A pattern is a memorized series of pan, tilt, zoom, and preset functions. It can be called on the pattern settings interface. There are up to 4 patterns for customizing.



Pattern function varies depending on positioning system models.

Setting a Pattern:

Steps:

1. In the PTZ control panel, click  to enter the pattern settings interface.
2. Select a pattern number from the list as shown in Figure 4-12.

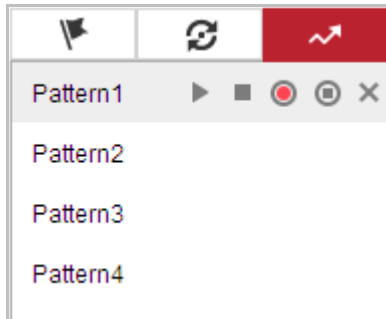







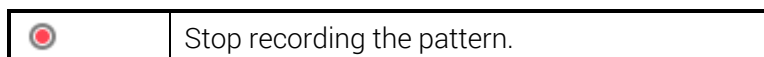

Figure 4-12 Patterns Settings Interface

3. Click  to enable recording the panning, tilting and zooming actions.
4. Use the PTZ control buttons to move the lens to the desired position after the information of **PROGRAM PATTERN REMAINNING MEMORY(%)** is displayed on the screen.
 - Pan the positioning system to the right or left.
 - Tilt the positioning system up or down.
 - Zoom in or out.
 - Refocus the lens.
5. Click  to save all the pattern settings.

Buttons on the Patterns interface:

Buttons	Description
	Start the selected patrol/pattern.
	Stop current patrol/pattern.
	Set the selected preset/patrol.
	Delete the selected preset/patrol/pattern.
	Start recording a pattern.



These 4 patterns can be operated separately and with no priority level.
When configuring and calling the pattern, proportional pan is valid; the limit stops and auto flip will be invalid; and the 3D positioning operation is not supported.

4.5 Playback

Purpose:

This section explains how to view the video files stored in the network disks or memory cards.

4.5.1 Play Back Video Files

Steps:

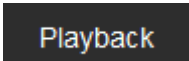
1. Click  on the menu bar to enter playback interface.

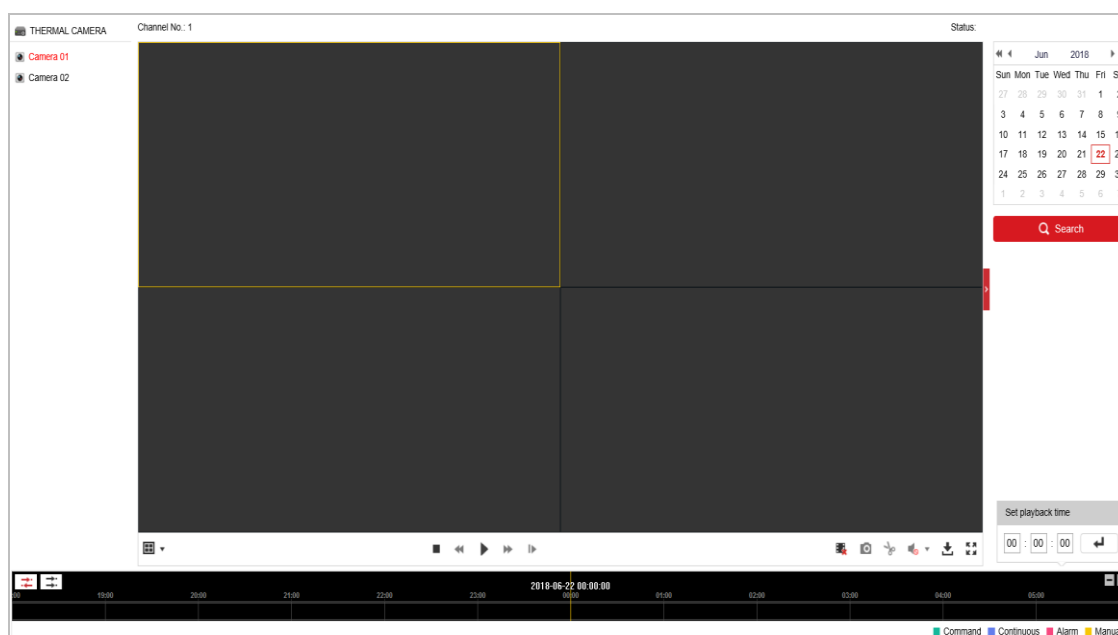
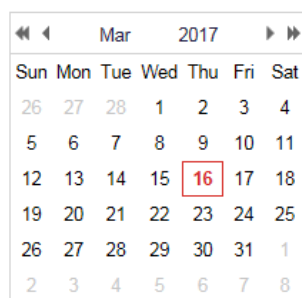



Figure 4-13 Playback Interface

2. Select the date and click .



Mar 2017						
Sun	Mon	Tue	Wed	Thu	Fri	Sat
26	27	28	1	2	3	4
5	6	7	8	9	10	11
12	13	14	15	16	17	18
19	20	21	22	23	24	25
26	27	28	29	30	31	1
2	3	4	5	6	7	8

Figure 4-14 Search Video















3. Click  to play the video files found on this date.

The toolbar on the bottom of Playback interface can be used to control playing process.





Figure 4-15 Playback Toolbar

Table 4-5 Description of the buttons

Button	Operation	Button	Operation
	Play		Capture a picture
	Pause		Start/Stop clipping video files
	Stop		Audio on and adjust volume/Mute
	Speed down		Download
	Speed up		Playback by frame
	Display in 1×1/2×2/3×3/4×4 window.		Show full screen
	Stop all Playback		Play recorded videos of different cameras asynchronously.
	Play recorded videos of different cameras synchronously.		



You can choose the file paths locally for downloaded playback video files and pictures in Local Configuration interface. Please refer to **Section 4.1 Configuring Local Parameters** for details.

Drag the progress bar with the mouse to locate the exact playback point. You can also input the time and click  to locate the playback point in the **Set playback time** field. You can also click  to zoom out/in the progress bar.

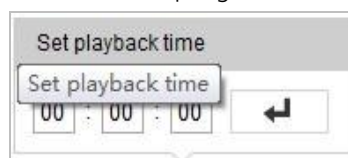

Figure 4-16 Set Playback Time

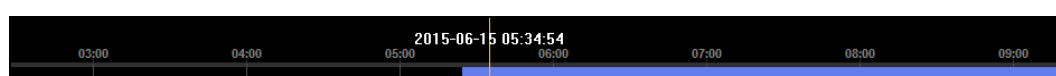

Figure 4-17 Progress Bar

The different colors of the video on the progress bar stand for the different video types as

shown in Figure 4-18.

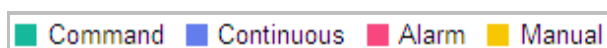



Figure 4-18 Video Types



Synchronously play recorded videos of different channels

Steps:

1. Click  to enable synchronous playback function.
2. Choose camera channels.
3. Setting date and time of recorded videos.
4. Click  to view the videos of optical channel and thermal channel synchronously.

Asynchronously play recorded videos of different channels

Steps:

1. Click  to enable asynchronous playback function.
2. Choose Channel No: 1.
3. Setting date and time of recorded videos.
4. Choose Channel No: 2.
5. Setting date and time of recorded videos.
6. Repeat step 2-5 to configure the date and time for different channels separately.
7. Click  to view the videos of optical channel and thermal channel asynchronously.

4.5.2 Downloading Video Files

Steps:

1. Click  on the playback interface. The pop-up menu is shown in Figure 4-19.
2. Set the start time and end time. Click **Search**. The corresponding video files are listed on the left.

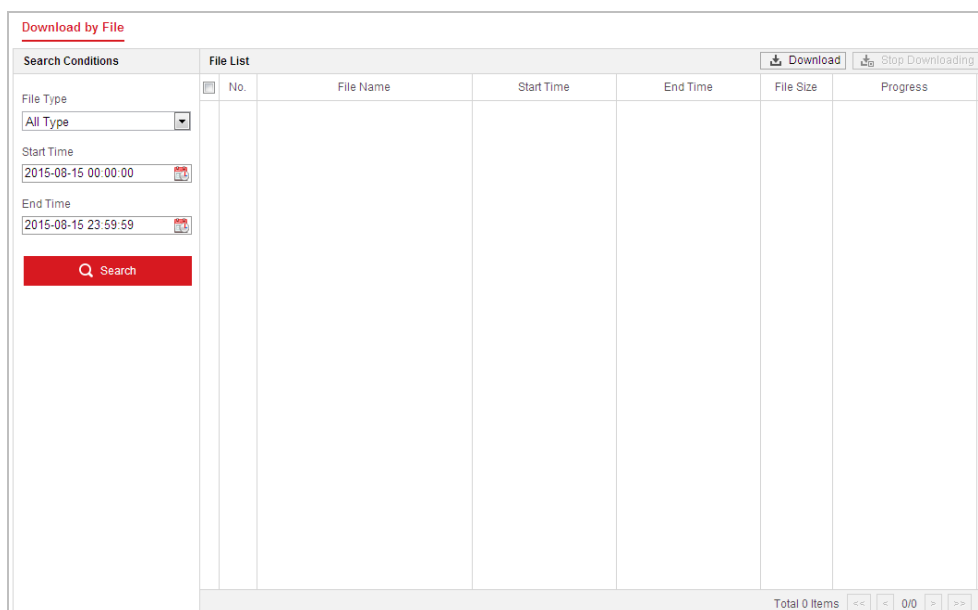



Figure 4-19 Video Downloading interface

3. Check the checkbox in front of the video files that you need to download.
4. Click  **Download** to download the video files.

4.6 Pictures

Purpose:

This section explains how to view the captured picture files stored in the network disks or the memory cards and download the captured pictures.

Steps:

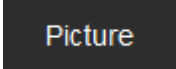
1. Click  on the menu bar to enter picture interface.

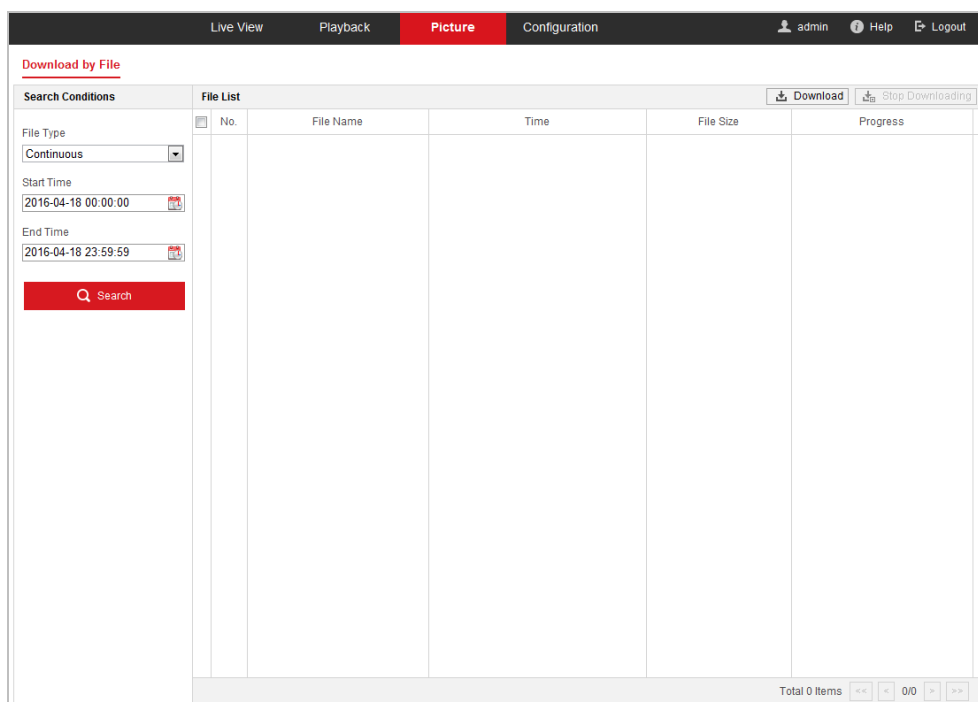



Figure 4-20 Picture Interface

2. Select the file type of capturing the pictures from the list as timing, alarm, motion, etc.
3. Set the start time and end time. Click **Search**. The corresponding picture files will be listed.
4. Check the checkbox in front of the files that you need to download.
5. Click  **Download** to download the files.

Chapter 5 System Configuration

5.1 Storage Settings

Before you start:

To configure record settings, please make sure that you have the network storage device within the network or the memory card inserted in your positioning system.

5.1.1 Configuring Recording Schedule

Purpose:

There are two kinds of recording for the positioning systems: manual recording and scheduled recording. In this section, you can follow the instructions to configure the scheduled recording. By default, the record files of scheduled recording are stored in the memory card (if supported) or in the network disk.

Steps:

1. Enter the Record Schedule settings interface:

Configuration > Storage > Schedule Settings > Record Schedule

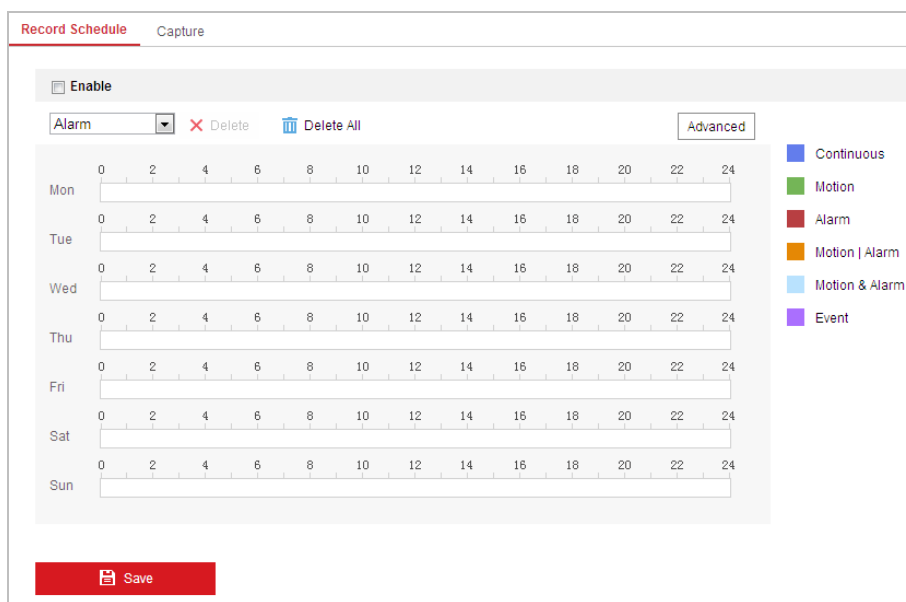

Figure 5-1 Recording Schedule Interface

2. Check the checkbox of **Enable** to enable scheduled recording.
3. To set the advanced settings of the positioning system, click **Advanced** to enter the advanced settings interface.

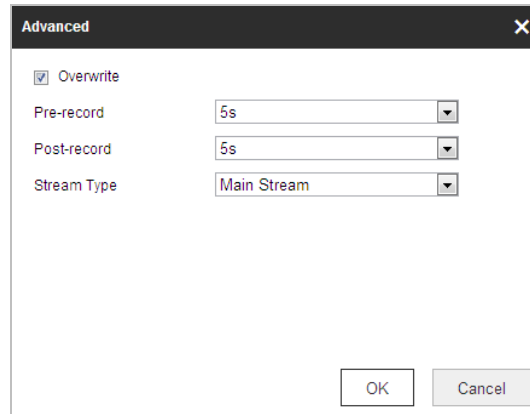

Figure 5-2 Record Parameters

Pre-record: The time you set to start recording before the scheduled time or the event. For example, if an alarm triggers recording at 10:00, and the pre-record time is set as 5 seconds, the positioning system starts to record at 9:59:55.

The Pre-record time can be configured as No Pre-record, 5 s, 10 s, 15 s, 20 s, 25 s, 30 s or not limited.



The pre-record time changes according to the video bitrate.

Post-record: The time you set to stop recording after the scheduled time or the event. For example, if an alarm triggered recording ends at 11:00, and the post-record time is set as 5 seconds, the positioning system records until 11:00:05.

The Post-record time can be configured as 5 s, 10 s, 30 s, 1 min, 2 min, 5 min or 10 min.

Stream Type: You can select the stream type for recording; Main Stream, Sub Stream and Third Stream are selectable. If you select the sub stream, you can record for a longer time with the same storage capacity.



The Pre-record and Post-record parameters vary depending on the models of positioning system.

4. Click **OK** to save the advanced setting.
5. Select a Record Type. The record type can be Continuous, Motion, Alarm, Motion | Alarm, Motion & Alarm, and Event.

Normal: If you select Continuous, the video will be recorded automatically according to the time of the schedule.

Record Triggered by Motion Detection: If you select Motion, the video will be recorded when the motion is detected. Besides configuring the recording schedule, you have to set the motion detection area and check the checkbox of **Trigger Channel** in the Linkage Method of Motion Detection settings interface. For detailed information, please refer to Section *Motion Detection*.

Record Triggered by Alarm: If you select Alarm, the video will be recorded when the alarm is triggered via the external alarm input channels. Besides configuring

the recording schedule, you have to set the Alarm Type and check the checkbox of **Trigger Channel** in the Linkage Method of Alarm Input settings interface. For detailed information, please refer to Section *Alarm Input*.

Record Triggered by Motion & Alarm: If you select Motion & Alarm, the video will be recorded when the motion and alarm are triggered at the same time. Besides configuring the recording schedule, you have to configure the settings on the Motion Detection and Alarm Input settings interfaces.

Record Triggered by Motion | Alarm: If you select Motion | Alarm, the video will be recorded when the external alarm is triggered or the motion is detected. Besides configuring the recording schedule, you have to configure the settings on the Motion Detection and Alarm Input settings interfaces.

Record Triggered by VCA events: If you select VCA, the video will be recorded when the either of the VCA events is triggered. Besides configuring the recording schedule, you have to configure the settings on the VCA interface.



VCA function varies depending on the models of positioning system.

Record Triggered by Event: If you select to record by event, the video will be recorded when any of the events is triggered.

6. Click  to save the settings.

5.1.2 Configuring Capture Schedule

Purpose:

You can configure the scheduled snapshot and event-triggered snapshot. The captured picture can be stored in the local storage or network storage.

Steps:

1. Enter the Snapshot settings interface:

Configuration > Storage > Storage Settings > Capture

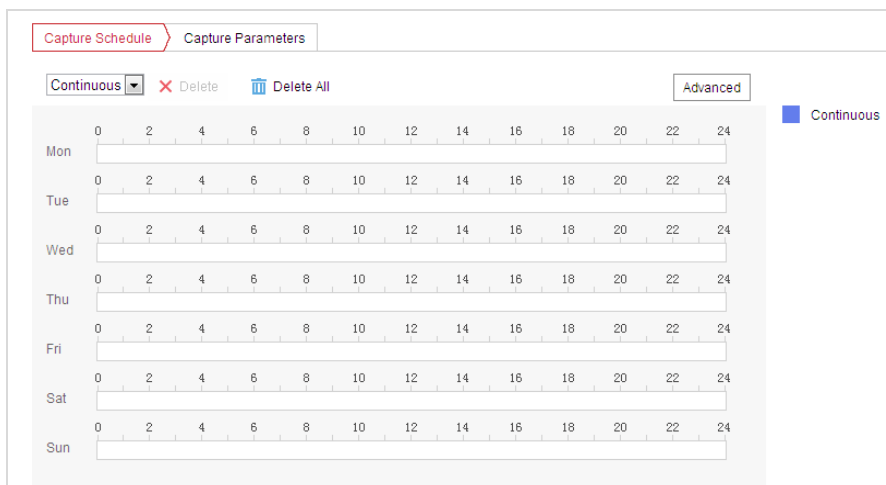
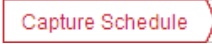



Figure 5-3 Snapshot Settings

2. Click  to enter the Capture Schedule interface.
3. Select the timeline of a certain day, click and drag the left button of the mouse to set the capture schedule (the start time and end time of the recording task).
4. After you set the scheduled task, you can click  and copy the task to other days (optional).
5. After setting the capture schedule, you can click a capture segment to display the segment capture settings interface to edit the segment capture parameters. (optional)

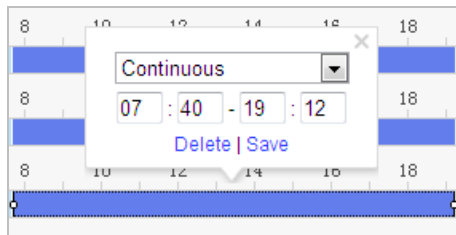





Figure 5-4 Segment Snapshot Settings

6. Click  to enter the advanced setting interface. You can select the stream type of the capture.
7. Click  to enter the Capture Parameters Interface.
8. Check the **Enable Timing Snapshot** checkbox to enable continuous snapshot, and configure the schedule of timing snapshot. Check the **Enable Event-triggered Snapshot** checkbox to enable event-triggered snapshot.
9. Select the format, resolution, quality of the snapshot.
10. Set the time interval between two snapshots.
11. Click  to save the settings.

Uploading to FTP



Please make sure that the FTP server is online.

You can follow below configuration instructions to upload the snapshots to FTP.

Upload continuous snapshots to FTP

Steps:

- 1) Configure the FTP settings and check **Upload Picture** checkbox in FTP Settings interface. Please refer to *Section 7.1.2 Configuring FTP Settings* for more details to configure FTP parameters.
- 2) Check the **Enable Timing Snapshot** checkbox.
- 3) Click **Edit** to set the snapshot schedule. Refer to *Section 5.2.1 Configuring Motion Detection*.

Upload event-triggered snapshots to FTP

Steps:

- 1) Configure the FTP settings and check **Upload Picture** checkbox in FTP Settings interface. Please refer to **Section 7.1.2 Configuring FTP Settings** for more details to configure FTP parameters.
- 2) Check **Upload to FTP** checkbox in Motion Detection Settings or Alarm Input interface. Refer to **Section 5.2.1 Configuring Motion Detection**.
- 3) Check the **Enable Event-triggered Snapshot** checkbox.

5.1.3 Configuring Net HDD

Before you start:

The network disk should be available within the network and properly configured to store the recorded files, log files, etc.

Steps:**Add the network disk**

1. Enter the NAS (Network-Attached Storage) settings interface:
Configuration > Storage > Storage Management > Net HDD

HDD Management Net HDD				
Net HDD				
HDD No.	Server Address	File Path	Type	Delete
1	10.10.36.61	/cxy_1	NAS	✘
Mounting Type: SMB/CIFS User Name: <input type="text" value="cxy1"/> Password: <input type="password" value="••••••"/> Test				
2	10.10.36.252	/dvr/yangjian_1	NAS	✘
3			NAS	✘

Figure 5-5 Select Net HDD Type

2. Enter the IP address and the file path of the network disk.
3. Select the mounting type. NFS and SMB/CIFS are selectable. You can set the user name and password to guarantee the security if SMB/CIFS is selected.



Please refer to the *NAS User Manual* for creating the file path.



For your privacy and to better protect your system against security risks, we strongly recommend the use of strong passwords for all functions and network devices. The password should be something of your own choosing (using a minimum of 8 characters, including upper case letters, lower case letters, numbers and special characters) in order to increase the security of your product. Proper configuration of all passwords and other security settings is the responsibility of the installer and/or end-user.

4. Click  to add the network disk.



After having saved successfully, you need to reboot the positioning system to activate the settings.

Initialize the added network disk.

1. Enter the HDD settings interface (**Configuration > Storage > Storage Management > HDD Management**), in which you can view the capacity, free space, status, type and property of the disk.

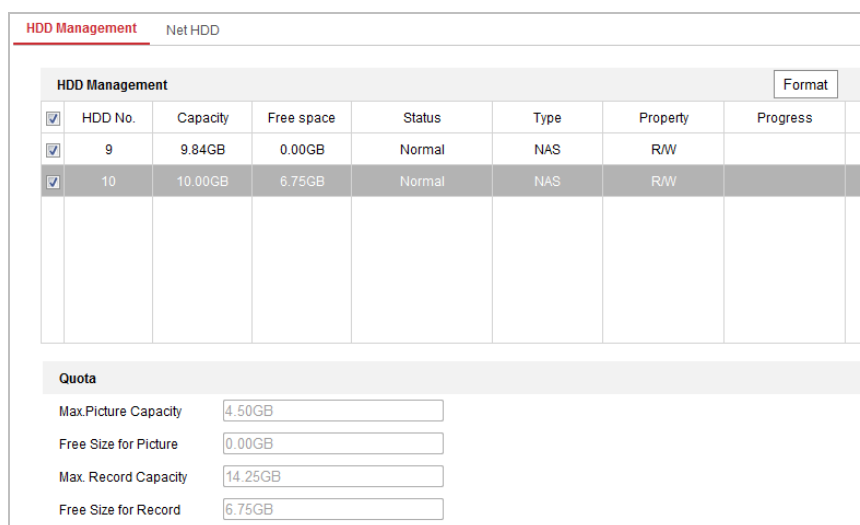

HDD Management								Format
<input checked="" type="checkbox"/>	HDD No.	Capacity	Free space	Status	Type	Property	Progress	
<input checked="" type="checkbox"/>	9	9.84GB	0.00GB	Normal	NAS	R/W		
<input checked="" type="checkbox"/>	10	10.00GB	6.75GB	Normal	NAS	R/W		

Quota	
Max. Picture Capacity	<input type="text" value="4.50GB"/>
Free Size for Picture	<input type="text" value="0.00GB"/>
Max. Record Capacity	<input type="text" value="14.25GB"/>
Free Size for Record	<input type="text" value="6.75GB"/>

Figure 5-6 Storage Management Interface

2. If the status of the disk is **Uninitialized**, check the corresponding checkbox to select the disk and click **Format** to start initializing the disk.
3. When the initialization completed, the status of disk will become **Normal** as shown in Figure 5-7.



HDD Management								Set	Format
<input checked="" type="checkbox"/>	HDD No.	Capacity	Free space	Status	Type	Property	Progress		
<input checked="" type="checkbox"/>	9	20.00GB	0.00GB	Formatting	NAS	R/W			

Figure 5-7 View Disk Status

Define the Quota for Record and Pictures

1. Input the quota percentage for picture and for record.
2. Click **Save** and refresh the browser page to activate the settings.

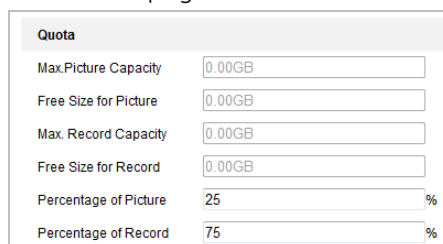

Quota	
Max. Picture Capacity	<input type="text" value="0.00GB"/>
Free Size for Picture	<input type="text" value="0.00GB"/>
Max. Record Capacity	<input type="text" value="0.00GB"/>
Free Size for Record	<input type="text" value="0.00GB"/>
Percentage of Picture	<input type="text" value="25"/> %
Percentage of Record	<input type="text" value="75"/> %

Figure 5-8 Quota Settings



Up to 8 NAS disks can be connected to the positioning system.
To initialize and use the memory card after insert it to the positioning system, please refer to the steps of NAS disk initialization



5.2 Event Configuration

Purpose:

This section explains how to configure the network positioning system to respond to alarm events, including motion detection, video tampering alarm input, alarm output and exception. These events can trigger the alarm actions, such as Send Email, Notify Surveillance Center, etc.

For example, when motion detection is triggered, the network positioning system sends a notification to an e-mail address.



On the event configuration page, click  to show the PTZ control panel or click  to hide it.

Click the direction buttons to control the pan/tilt movements.

Click the zoom/iris/focus buttons to realize lens control.

The functions vary depending on the models of positioning system.

5.2.1 Configuring Motion Detection

Purpose:

Motion detection is a feature which can trigger alarm actions and actions of recording videos when the motion occurred in the surveillance scene.

Steps:

1. Enter the motion detection setting interface:
Configuration > Event > Basic Event > Motion Detection
2. Select the channel to set the motion detection.
3. Check the checkbox of the **Enable Motion Detection** to enable this function.
You can check the **Enable Dynamic Analysis for Motion** checkbox if you want the detected object get marked with rectangle in the live view.
4. Select the configuration mode as **Normal** or **Expert** and set the corresponding motion detection parameters.

Normal

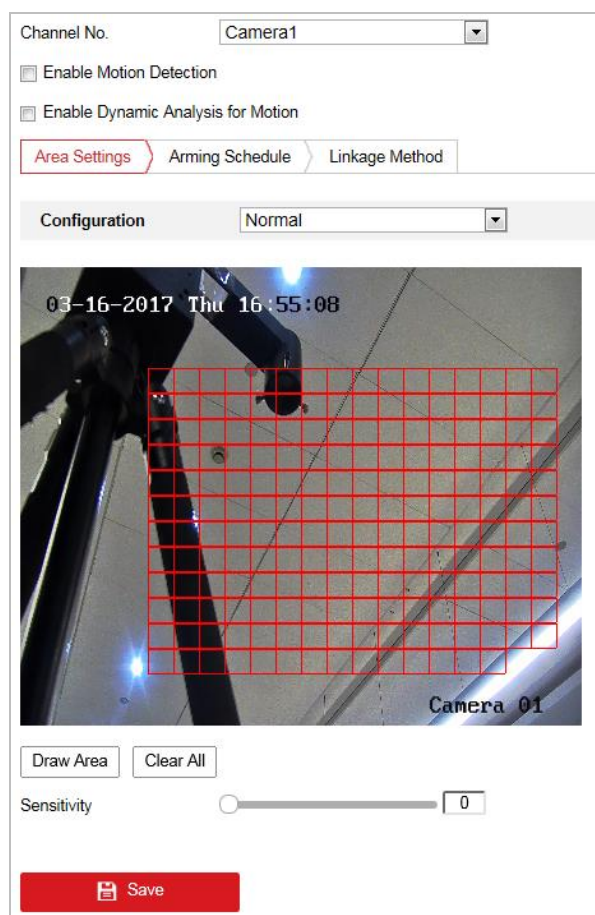

Figure 5-9 Motion Detection Settings-Normal

Steps:

- (1) Click **Draw Area** and drag the mouse on the live video image to draw a motion detection area.
- (2) Click **Stop Drawing** to finish drawing.



You can draw up to 8 motion detection areas on the same image.

You can click **Clear All** to clear all of the areas.

- (3) Move the slider **Sensitivity** to set the sensitivity of the detection.

Expert

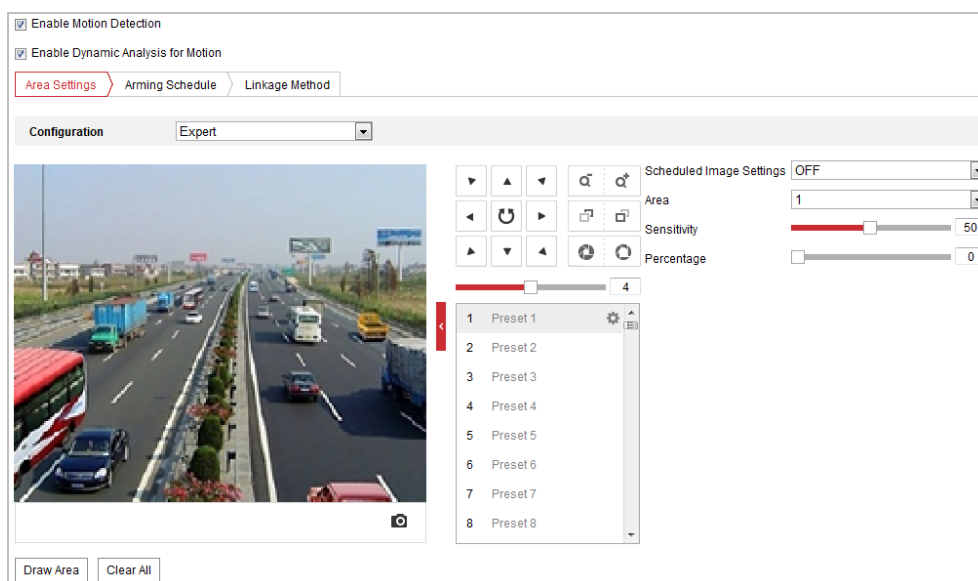

Figure 5-10 Motion Detection Settings-Expert

Steps:

- (1) Set the **Schedule Image Settings**, there are **OFF**, **Auto-Switch** and **Scheduled-Switch** selectable. If the schedule image switch mode is enabled, you can configure the detection rule for the day and night separately.
 - OFF:** Disable the day and night switch.
 - Auto-Switch:** Switch the day and night mode according to the illumination automatically.
 - Scheduled-Switch:** Switch to the day mode at 6:00 a.m., and switch to the night mode at 18:00 p.m..
- (2) Select **Area No.** to configure in the dropdown list.
- (3) Set the values of sensitivity and proportion of object on area.
 - Sensitivity:** The greater the value is, the easier the alarm will be triggered.
 - Proportion of Object on Area:** When the size proportion of the moving object exceeds the predefined value, the alarm will be triggered. The less the value is, the easier the alarm will be triggered.
5. Set the **Arming Schedule** for Motion Detection.
 - (1) Click **Arming Schedule** tab to enter the arming schedule setting interface.

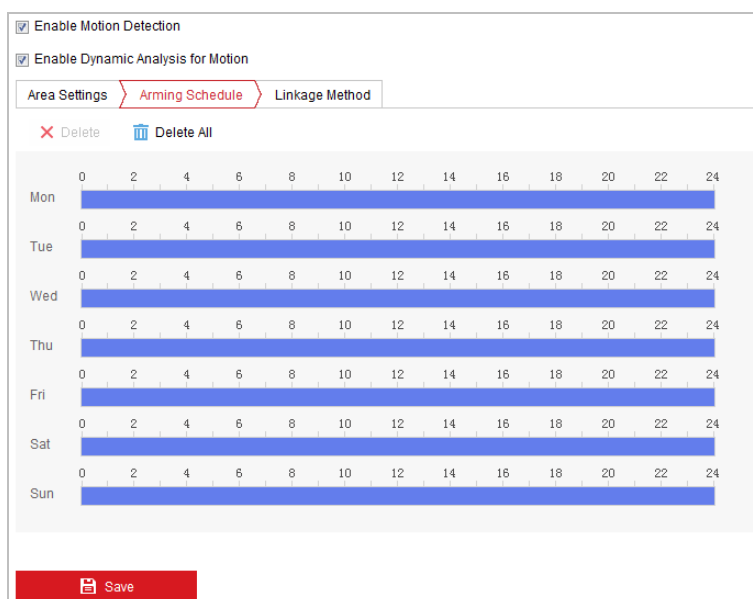



Figure 5-11 Arming Schedule

- (2) Select the timeline of a certain day, click and drag the mouse to set the arming schedule (the start time and end time of the arming task).
- (3) After you set the scheduled task, you can click  and copy the task to other days (optional).

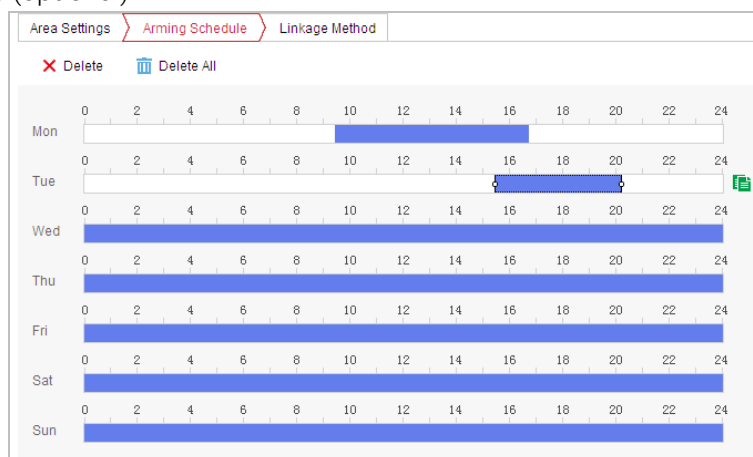

Figure 5-12 Arming Time Schedule

- (4) After setting the arming schedule, you can click a segment to display the segment arming settings interface to edit the segment record parameters (optional).

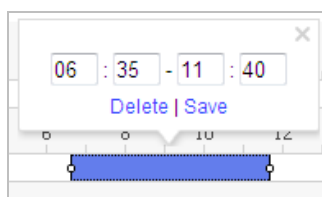

Figure 5-13 Segment Arming Settings

- (5) Click  to save the settings.



The time of each period cannot be overlapped. Up to 8 periods can be configured for each day.

- Set the **Alarm Actions** for Motion Detection.

Click **Linkage Method** tab to enter the **Linkage Method** interface.

You can specify the linkage method when an event occurs. The following contents are about how to configure the different types of linkage method.

Normal Linkage	Trigger Alarm Output	Trigger Recording
<input type="checkbox"/> Send Email	<input type="checkbox"/> A->1	<input type="checkbox"/> A1
<input type="checkbox"/> Notify Surveillance Center		
<input type="checkbox"/> Upload to FTP/Memory Card/...		

Figure 5-14 Linkage Method

Check the checkbox to select the linkage method. Notify Surveillance Center, Send Email, Upload to FTP/Memory/NAS, Trigger Alarm Output and Trigger Recording are selectable.

Notify Surveillance Center

Send an exception or alarm signal to remote management software when an event occurs.

Send Email

Send an email with alarm information to a user or users when an event occurs.



To send the Email when an event occurs, you need to refer to **Section Configuring Email Settings** to set the Email parameters.

Upload to FTP/Memory/NAS

Capture the image when an alarm is triggered and upload the picture to a FTP server.



You need a FTP server and set FTP parameters first. Refer to *Section Configuring FTP Settings* for setting FTP parameters.

Trigger Alarm Output

Trigger one or more external alarm outputs when an event occurs.



To trigger an alarm output when an event occurs, please refer to *Section 5.2.4 Configuring Alarm Output* to set the alarm output parameters.

Trigger Recording

Record a video when an event occurs.



You have to set the recording schedule to realize this function. Please refer to *Section 5.1.1 Configuring Recording Schedule* for settings the recording schedule.

5.2.2 Configuring Video Tampering Alarm

Purpose:

You can configure the positioning system to trigger the alarm actions when the lens is covered.

Steps:

1. Enter the Video Tampering settings interface :
Configuration > Event > Basic Event > Video Tampering
2. Select the channel to set the video tampering alarm.

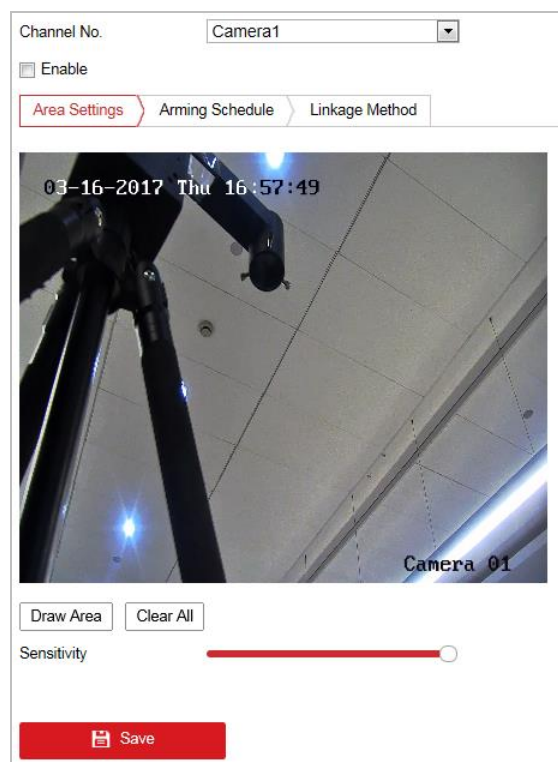

Figure 5-15 Tampering Alarm

3. Check **Enable** checkbox to enable the tampering detection.
4. Click **Arming Schedule** tab to enter the arming schedule setting interface. The arming schedule configuration is the same as the setting of the arming schedule for motion detection. Refer to *Section 5.2.1 Configuring Motion Detection*.
5. Click **Linkage Method** tab to select the linkage method taken for tampering, notify surveillance center, send email and trigger alarm output are selectable. Refer to *Section 5.2.1 Configuring Motion Detection*.
6. Click **Save** to save the settings.

5.2.3 Configuring Alarm Input

Steps:

1. Enter the Alarm Input settings interface:
Configuration > Event > Basic Event > Alarm Input
2. Choose the alarm input No. and the Alarm Type. The alarm type can be NO (Normally Open) and NC (Normally Closed).
3. Edit the name in **Alarm Name** (cannot copy) to set a name for the alarm input (optional).

Figure 5-16 Alarm Input Settings

4. Click **Arming Schedule** tab to enter the arming schedule setting interface. The arming schedule configuration is the same as the setting of the arming schedule for motion detection. Refer to **Section 5.2.1 Configuring Motion Detection**.
5. Click **Linkage Method** tab to select the linkage method taken for alarm input, including Notify Surveillance Center, Send Email, Upload to FTP/Memory Card/NAS, Trigger Alarm Output and Trigger Recording. Refer to **Section 5.2.1 Configuring Motion Detection**.
6. You can also choose the PTZ linking for the alarm input. Check the relative checkbox and select the No. to enable Preset Calling, Patrol Calling or Pattern Calling.
7. You can copy your settings to other alarm inputs.
8. Click **Save** to save the settings.

Figure 5-17 Linkage Method

5.2.4 Configuring Alarm Output

Steps:

1. Enter the Alarm Output settings interface:
Configuration > Event > Basic Event > Alarm Output
2. Select one alarm output channel in the **Alarm Output** dropdown list.
3. Set a name in (cannot copy) for the alarm output (optional).
4. The **Delay** time can be set to **5sec, 10sec, 30sec, 1min, 2min, 5min, 10min** or **Manual**. The delay time refers to the time duration that the alarm output remains in effect after alarm occurs.
5. Click tab to enter the arming schedule setting interface. The time schedule configuration is the same as the settings of the arming schedule for motion detection. Refer to *Section 5.2.1 Configuring Motion Detection*.

Alarm Output No. IP Address

Delay Alarm Name

Alarm Status (cannot copy)

Mon	0	2	4	6	8	10	12	14	16	18	20	22	24
Tue	0	2	4	6	8	10	12	14	16	18	20	22	24
Wed	0	2	4	6	8	10	12	14	16	18	20	22	24
Thu	0	2	4	6	8	10	12	14	16	18	20	22	24
Fri	0	2	4	6	8	10	12	14	16	18	20	22	24
Sat	0	2	4	6	8	10	12	14	16	18	20	22	24
Sun	0	2	4	6	8	10	12	14	16	18	20	22	24

Figure 5-18 Alarm Output Settings

6. You can copy the settings to other alarm outputs.
7. Click to save the settings.

5.2.5 Handling Exception

The exception type can be HDD full, HDD error, network disconnected, IP address conflicted and illegal login to the positioning systems.

Steps:

1. Enter the Exception settings interface:
Configuration > Event > Basic Event > Exception
2. Check the checkbox to set the actions taken for the Exception alarm. Refer to **Section 5.2.1 Configuring Motion Detection**.

Exception Type: HDD Full	
<input type="checkbox"/> Normal Linkage	<input type="checkbox"/> Trigger Alarm Output
<input type="checkbox"/> Send Email	<input type="checkbox"/> A->1
<input type="checkbox"/> Notify Surveillance Center	<input type="checkbox"/> A->2



Figure 5-19 Exception Settings

3. Click  to save the settings.

5.2.1 Detecting Audio Exception

Purpose:

When you enable this function and audio exception occurs, the alarm actions will be triggered.

Steps:

1. Enter the video audio exception detection interface:

Configuration > Event > Smart Event > Audio Exception Detection

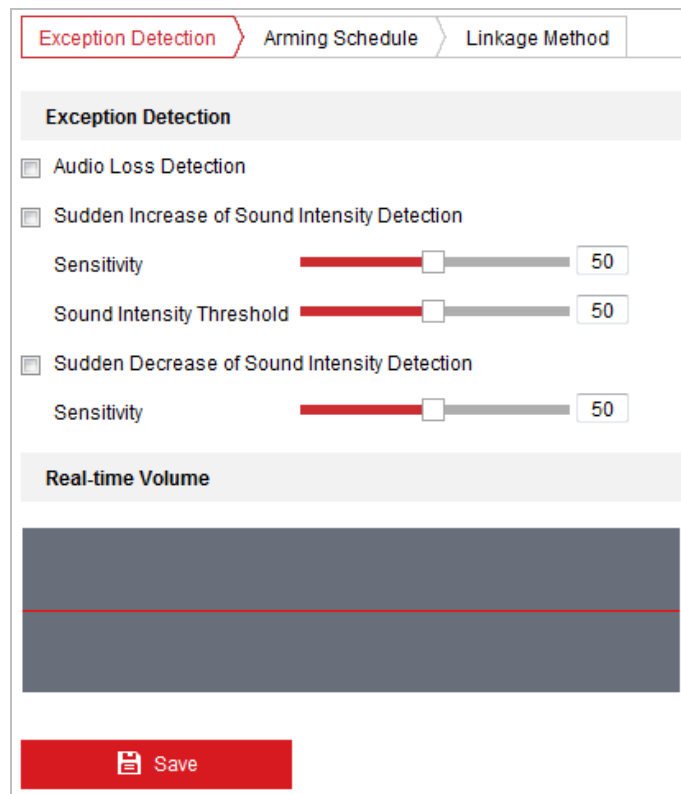

Figure 5-20 Audio Exception Detection

2. Check the checkbox of **Audio Loss Detection** to enable the audio input exception detection.
3. Check the checkbox of **Sudden Increase of Sound Intensity Detection** checkbox to enable the sudden rise detection.

Sensitivity: Range [1-100], the smaller the value the more severe the sound change will trigger the detection.

Sound Intensity Threshold: Range [1-100], it can filter the sound in the environment, the louder the environment sound, the higher the value should be. You can adjust it according to the actual environment.
4. Check the checkbox of **Sudden Decrease of Sound Intensity Detection** checkbox to enable the sudden drop detection.

Sensitivity: Range [1-100], the smaller the value the more severe the sound change will trigger the detection.
5. Click **Arming Schedule** tab to enter the arming schedule setting interface. The time schedule configuration is the same as the settings of the arming schedule for motion detection. Refer to *Section 5.2.1 Configuring Motion Detection*.
6. Click **Linkage Method** tab to select the linkage method taken for the audio input exception, Notify Surveillance Center, Send Email, Trigger Alarm Output and Trigger Recording are selectable. Refer to *Section 5.2.1 Configuring Motion Detection*.

7. Click  to save the settings.

5.3 Fire Source Detection Configuration



The functions vary depending on the models of positioning system.

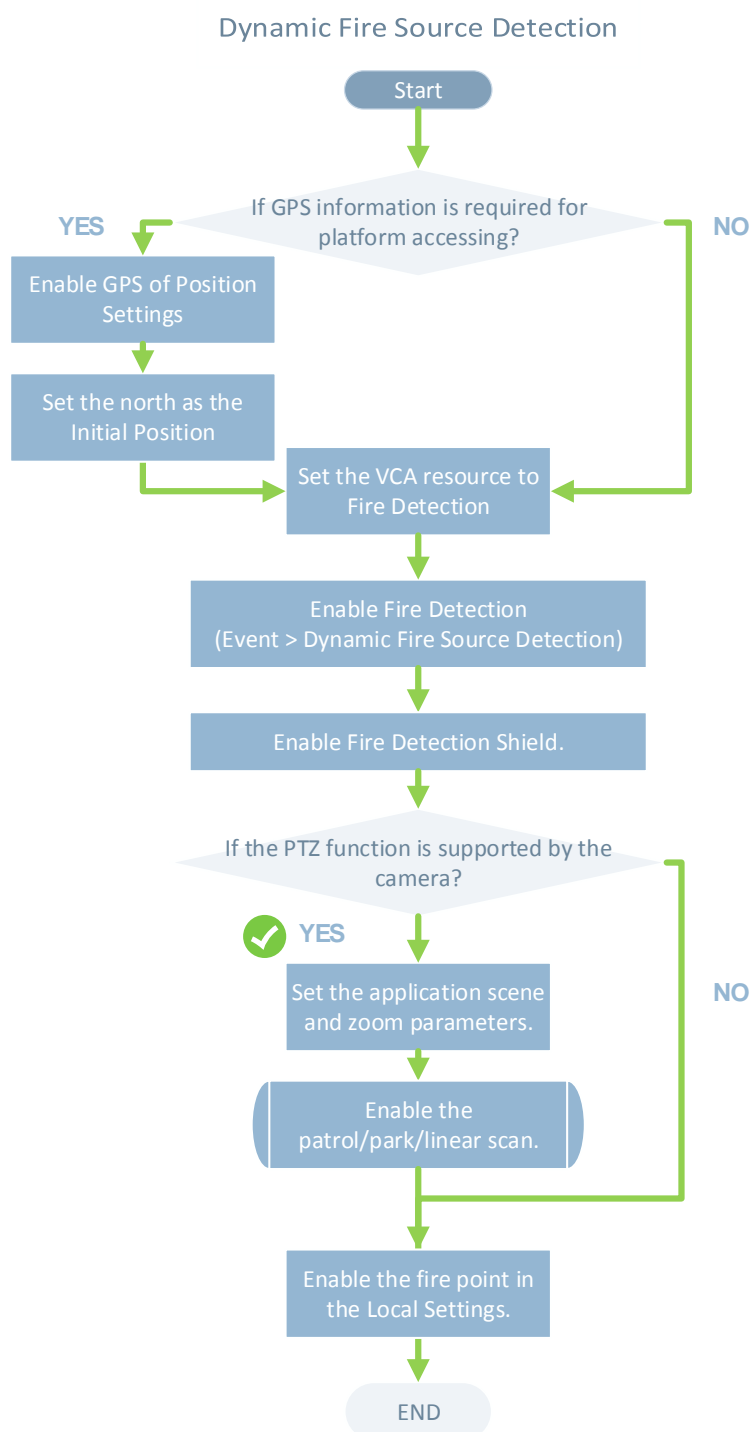

5.3.1 Configuring Initial Position

Purpose:

The initial position is the origin of PTZ coordinates. It can be the factory default initial position. You can also customize the initial position according to your own demand. If you connect the device to the system platform, the platform can mark all the fire positions.

Steps:

1. Enter the Position Settings interface:

Configuration > PTZ > Position Settings.

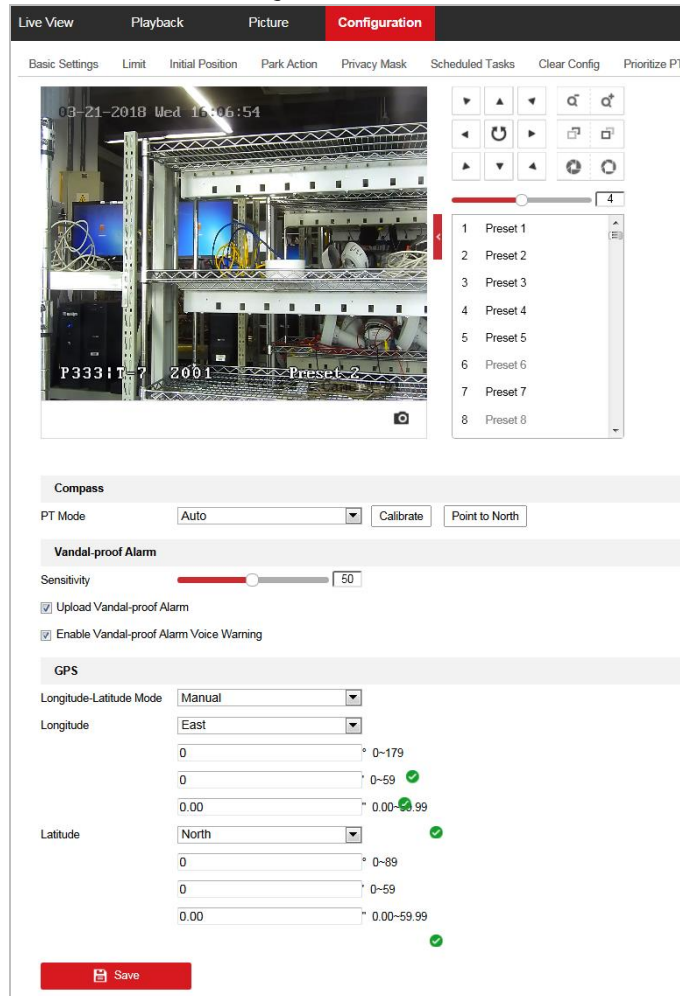

Figure 5-21 Position Settings

2. Set the compass parameters.
 - (1) Select PT Mode as **Manual**.
 - (2) Click the PTZ control buttons to find the north direction; you can also call a defined preset and set it as the north direction.
 - (3) Click **Set as North** to save the position.
 - (4) Optionally, you can click **Point to North** to move the device to the north direction if the north direction was once saved.
3. Set the sensitivity of Vandal-proof Alarm. The higher the value is, more easily the

alarm will be triggered.

4. Enable or disable the alarm uploading and alarm voice warning function.
5. Set GPS settings.
 - (1) Select Longitude-Latitude Mode as **Manual**.
 - (2) Select longitude and latitude as East or West according to the actual position.
 - (3) Enter the value of longitude and latitude in three textboxes.
6. Click **Point to North** and save.
7. Enter the Initial Position Configuration interface:

Configuration > PTZ > Initial Position

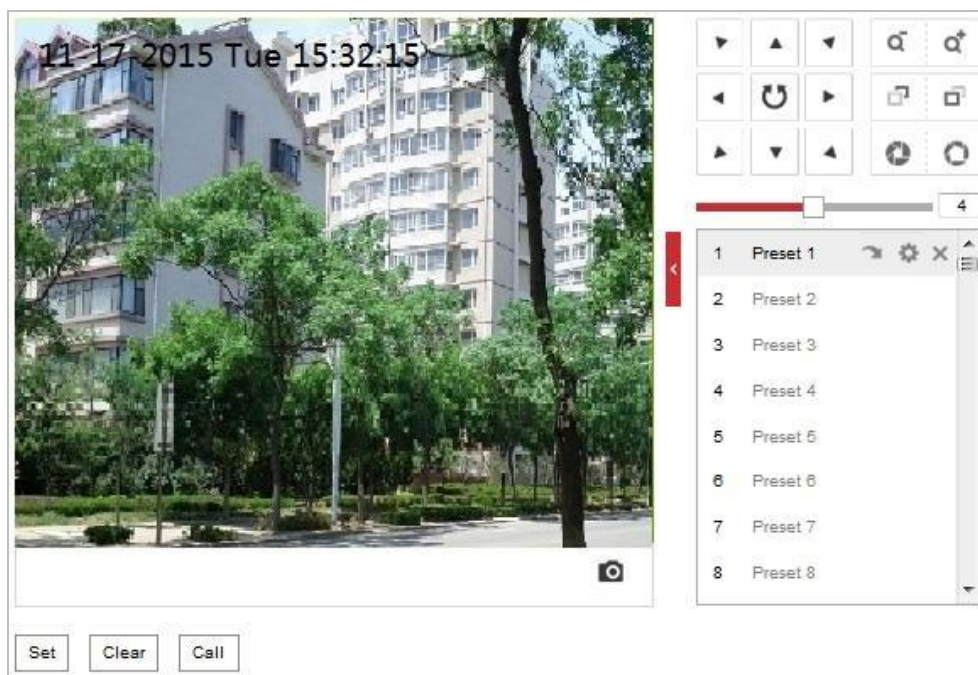



Figure 5-22 PTZ Configuration

1. Click the PTZ control buttons to find a position as the initial position of the positioning system; you can also call a defined preset and set it as the initial position of the positioning system.
2. Click **Set** to save the position.

Call/delete an Initial Position:

You can click  to call the initial position. You can click  to delete the initial position and restore the factory default initial position.

5.3.2 Configuring Dynamic Fire Source Detection

Purpose:

When you enable this function and fire source or smoke is detected, the alarm actions will be triggered. You can set different detection mode, fire source zoom mode, and so on.

Steps:

1. Enter **Configuration>System>Maintenance>VCA Resource Type** to select **Temperature Measurement + Fire Detection** as VCA Resource Type.
2. Enter the fire source detection interface:

Configuration > Event > Smart Event > Dynamic Fire Source Detection

The screenshot displays the configuration interface for Dynamic Fire Source Detection. At the top, there are three tabs: 'Audio Exception Detection', 'Dynamic Fire Source Detection' (which is active), and 'Fire Source Region Shield'. Below the tabs, the 'Channel No.' is set to 'Camera 02'. There are three sub-tabs: 'Basic Parameter' (selected), 'Arming Schedule', and 'Linkage Method'. Under 'Basic Parameter', the 'Application Scene' is set to 'Straw Burning' and the 'Installation Height' is set to 50 m. The 'Dynamic Fire Source Detection' section is expanded, showing a checkbox for 'Enable Dynamic Fire Source Detection' which is unchecked. Below this, 'Detection Mode' is set to 'by Multiple Frame', 'Sensitivity' is set to 12, 'Hold-and-Alarm Mode' is set to 'Auto', 'Dwell Time' is set to 5 s, and 'Fire Source Zoom Ratio' is set to 'Auto'. The 'Version' is listed as 'V2.7.1build20180211'. At the bottom, there is a checked checkbox for 'Cancel Repeated Alarm' and a red 'Save' button.

Figure 5-23 Fire Source Detection

3. Check **Enable Dynamic Fire Source Detection**.
4. Select the **Application Scene** from the list. Forest-Fire Prevention, Straw Burning, High-building, and Indoor/Perimeter are selectable. Set the **Installation Height** for scene if required.
5. Set the fire detection parameters:

Detection Mode: Select detection mode as **by Multiple Frame**, and the system alarms with high accuracy. Select detection mode as **by Single Frame**, and the system alarms with short delay.

Sensitivity: Range [1-100], the smaller the value is, the fire source of lower temperature can be detected.

Hold-and-Alarm Mode: The system will stop when it detects the fire source. You can set the duration while it keeps still.

- In **Auto** mode, you can set the dwell time, range [0-120]. During the dwell time the camera stays still where it detects the fire source when performing auto scan, patrol, pattern, scheduled task, and park action.
- In **Manual** Mode, the device stays still where it detects the fire source, until you manually moves the camera.

Fire Source Zoom Ratio: Set the zoom ratio of the optical channel when it detects the fire source. In Auto mode, the optical channel changes its zoom ratio until two channels have the same field of view. In Manual mode, you can set the optical

zoom ratio.

Cancel Repeated Alarm: Enable this function to trigger alarm only once for same place during one day.

6. Check the checkbox of **Display Fire Source Frame on Stream** to display a red frame around the fire source on stream when fire occurs. (Optional)
7. Check the checkbox to select the linkage method taken for the alarm input. *Refer to Step 3 in Section 5.2.1 Configuring Motion Detection.* In the field of **Other Linkage**, you can check the checkbox to enable the alarm output (The alarm output number varies depending on device ability).
8. Click  to save the settings.



5.3.3 Configuring Fire Source Detection Shield

Purpose:

Fire Source Detection Shield enables you to shield certain areas from being detected in fire source detection.



The Fire Source Detection Shield function is supported by the optical lens only.

Steps:

1. Enter the Fire Source Detection Shield Setting interface:
Configuration > Event > Smart Event > Fire Source Detection Shield

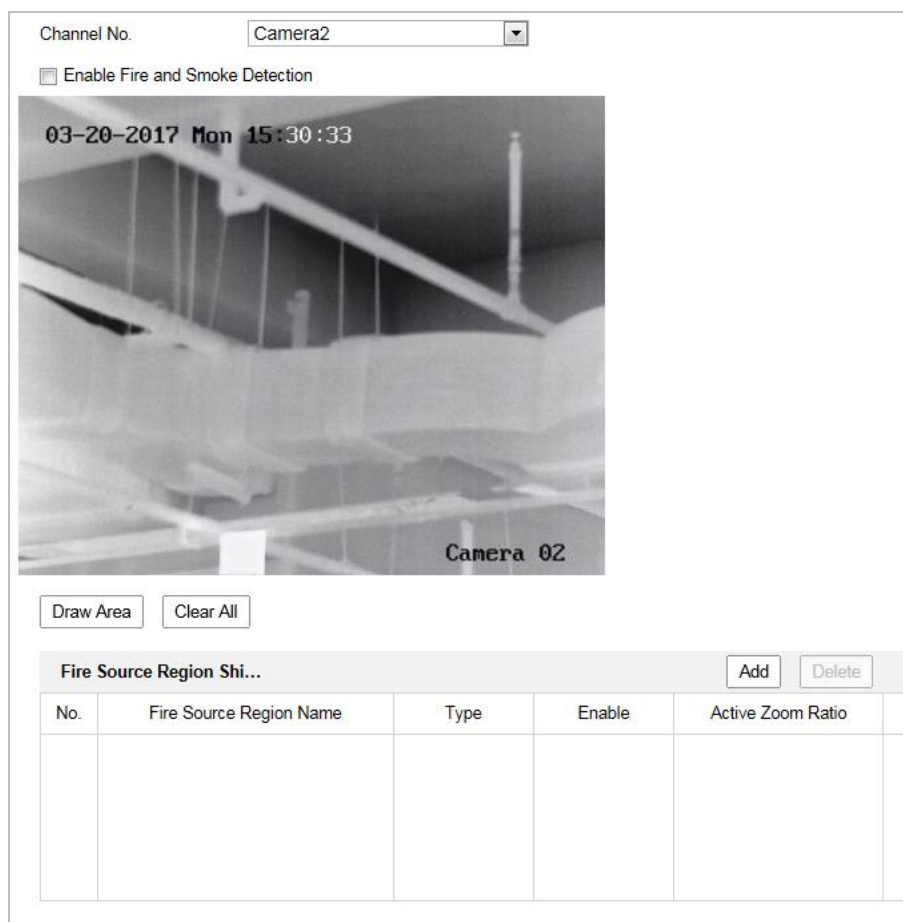

Figure 5-24 Fire Source Detection Shield

2. Click the PTZ control buttons to find the area you want to shield from the smoke detection.
3. Click **Draw Area** and drag the mouse in the live video window to draw the area.
4. You can drag the corners of the red rectangle area to change its shape and size.
5. Click **Stop Drawing** to finish drawing or click **Clear All** to clear all of the areas you set without saving them.
6. Set the value of **Active Zoom Ratio** on your demand, and then the shield will only appear when the zoom ratio is greater than the predefined value.
7. Click **Add** to save the smoke detection shield, and it will be listed in the **Fire Source Detection Shield List** area; you can select a region and click **Delete** to delete it from the list; you can also define the color of the regions.
8. Check the checkbox of **Enable Fire Source Detection Shield** to enable this function.



You are allowed to draw up to 24 areas on the same image.

9. Click  **Save** to save the settings.

5.4 Temperature Measurement

Purpose:

When you enable this function, it measures the actual temperature of the spot being monitored. The device alarms when temperature exceeds the temperature threshold value.

Before You Start:

Enter **Configuration > Advanced Configuration > System > VCA Resource Type** to select **Temperature Measurement + Behavior Analysis** as VCA Resource Type.

5.4.1 Temperature Measurement Configuration

Steps:

1. Enter **Configuration > Temperature Measurement > Basic Settings** Configuration.

Basic Settings	Advanced Settings	Linkage Method	Search History temperature
Channel No.	Camera 02		
<input checked="" type="checkbox"/> Enable Temperature Measurement			
<input checked="" type="checkbox"/> Enable Color-Temperature			
<input checked="" type="checkbox"/> Display Temperature Info. on Stream			
<input type="checkbox"/> Add Original Data on Capture			
<input type="checkbox"/> Add Original Data on Stream			
Data Refresh Interval	3	s	
Unit	Degree Celsius(°C)		
Temperature Range	-20.0~150.0		
Version	V1.1.5build20180117		
<input type="button" value="Save"/>			

Figure 5-25 Temperature Measurement Configuration

2. Check the checkboxes of the interface to set the temperature measurement configurations.

Enable Temperature Measurement: Check the checkbox to enable temperature measurement function.

Enable Color-Temperature: Check the checkbox to display temperature pallet in live view.

Display Temperature Info. on Stream: Check the checkbox to display temperature information in live view.

Add Original Data on Capture: Check the checkbox to add original data on capture.

Add Original Data on Stream: Check the checkbox to add original data on stream.

Data Refresh Interval: Select the data refresh interval from 1s to 5s.

Unit: Display temperature with Degree Celsius (°C)/ Degree Fahrenheit (°F)/ Degree Kelvin (K).

Temperature Range: Set the temperature range.

Version: View the version of current algorithm.

3. Click **Save** to save the settings.

5.4.2 Configuring Temperature Measurement Rule

Before you start:

The temperature measurement function is usually used together with alarm function. You can set the alarm linkage so that any alarm/pre-alarms can trigger the connected alarm.

Purpose:

This function is used for measuring the temperature of detected spot and the device compares temperature of selected regions and alarms.

Steps:

(For Normal Mode)

1. Enter **Configuration > Temperature Measurement > Advanced Settings**.
2. Select the configuration mode as **Normal**.
3. Configure the parameters.

Emissivity: Set the emissivity of your target. Note: The emissivity of each object is different.

Distance (m): The straight-line distance between the target and the device.

Pre-Alarm: When the temperature of target exceeds the **Pre-Alarm Threshold**, and this status keeps NOT shorter than the **Filtering Time**, it triggers the Pre-Alarm.

Check the checkbox of Pre-Alarm Output to set link the pre-alarm with the connected alarm device.

Alarm: When the temperature of target exceeds the **Alarm Threshold**, and this status keeps NOT shorter than the **Filtering Time**, it triggers the Alarm.

Check the checkbox of **Alarm Output** to set link the pre-alarm with the connected alarm device.

4. Click **Save**.

Figure 5-26 Temperature Measurement Configuration

(For Expert Mode)

1. Enter **Configuration > Temperature Measurement > Advanced Settings**.
2. Select the configuration mode as **Expert**.
3. Click **Synchronize FOV** this button to synchronize the FOV of thermal light channel and optical light channel.
4. Configure the parameters.

Name: You can customize the rule name.

Type: Select **Point**, **Line**, or **Area** as rule type.

Emissivity: Set the emissivity of your target. The emissivity of each object is different, you can refer to the Appendix for details.

Distance (m): The straight-line distance between the target and the device.

Reflective Temperature: If there is any object reflecting to the target, e.g., a mirror, enter the background temperature value/the reflecting object's temperature value.

If not, uncheck the checkbox.

Tolerance Temperature: The triggered alarm does NOT stop until the temperature/temperature difference is lower/higher than rule temperature by tolerance temperature.

Example: set tolerance temperature as 3°C, set alarm temperature as 55°C. It alarms when its temperature reaches 55°C and only when the temperature is below 52°C will the alarm be cancelled.

Basic Settings **Advanced Settings** Linkage Method Search History temperature

Channel No. Camera 02

Configuration Expert

Device Temperature(°C): 46

06-22-2018 Fri 19:30:46

-40.5°C

2001 Camera 02

4

1 Preset 1

2 Preset 2

3 Preset 3

4 Preset 4

5 Preset 5

6 Preset 6

7 Preset 7

8 Preset 8

Clear All Synchronize FOV Area's Temperature Comparison

Enable	ID	Name	Type	Emissivity	Distance(...)	Reflective Temp...	Alarm Rule
<input type="checkbox"/>	1		Point	0.96	30	<input type="checkbox"/> 20	<input checked="" type="checkbox"/>
<input type="checkbox"/>	2		Point	0.96	30	<input type="checkbox"/> 20	<input checked="" type="checkbox"/>

Figure 5-27 Temperature Measurement Configuration

5. Check the Enable checkbox to enable the alarm rule.

For Point Rule:

a) Click  to show the Alarm Rule setting interface.

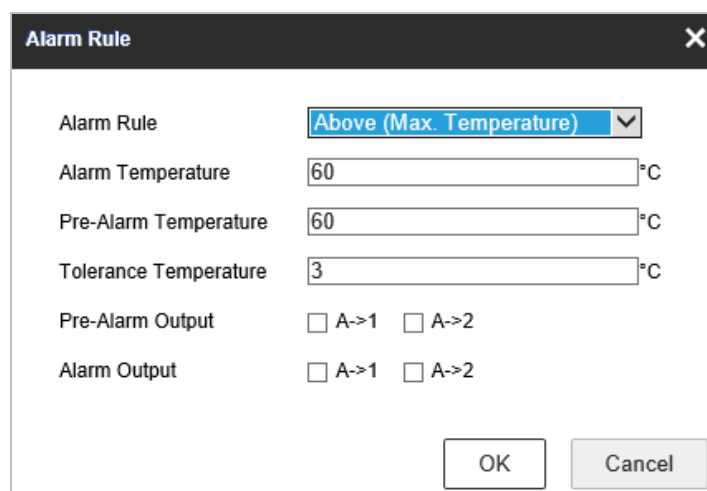

Figure 5-28 Alarm Rule Settings (Point)

- b) Set the **Alarm Rule**.
- c) Set the **Alarm Temperature**, **Pre-Alarm Temperature**, and **Tolerance Temperature**.
- d) (optional) Set the **Filtering Time**.
- e) Set the **Pre-Alarm Output** and **Alarm Output** with the connected alarm sensor and alarm device.

Example: select **Alarm Rule** as **Above (Average Temperature)**, set the **Alarm Temperature** to 50 °C and **Filtering Time** as 5 s, and then the device alarms when its average temperature keeps being above 50 °C for over 5 s.

For Line and Area Rule:

- a) Click  to show the Alarm Rule setting interface.

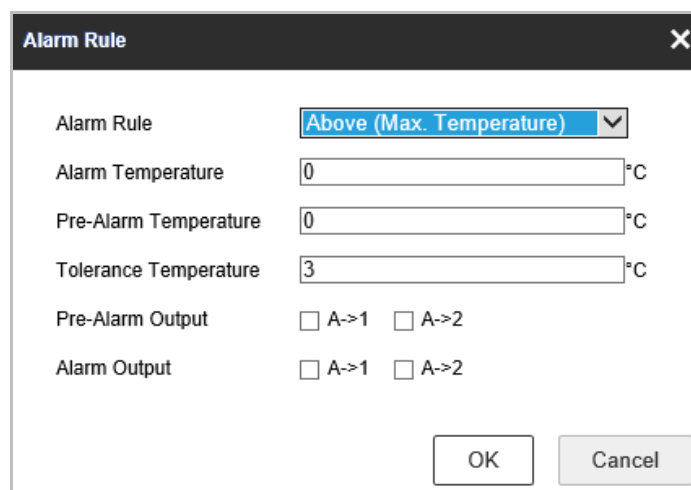

Figure 5-29 Alarm Rule Settings (Line)

- b) Set the **Alarm Rule**.
- c) Set the **Alarm Temperature**, **Pre-Alarm Temperature**, and **Tolerance Temperature**.
- d) (optional) Set the **Filtering Time**.
- e) Set the **Pre-Alarm Output** and **Alarm Output** with the connected alarm sensor and alarm device.

Example: select Alarm Rule as Min. Temperature is Lower than, and set the Alarm Temperature to 40 °C, and the device alarms when the minimum temperature is lower than 40 °C.

For Area Temperature Comparison:

Make sure you have enabled the areas for comparison.

- a) Click Area's Temperature Comparison to enter the area temperature comparison interface.
- b) Select the areas.

Figure 5-30 Area Temperature Comparison Alarm

- c) Select the comparison rule.
- d) Set the temperature difference threshold value.

Example: select **Area 1** and **Area 11**, and set the comparison rule as **Above (Max. Temperature)**, and set the temperature difference threshold to 5 °C.

The device alarms when the difference of two areas' maximum temperature is above 5 °C.

5.4.3 Linkage Method

Purpose:

Set the linkage method of the alarm.

Steps:

1. Enter **Configuration > Temperature Measurement > Linkage Method**.
2. Set the arming schedule and linkage method.

Arming Schedule: Click on the time bar and drag the mouse to select the time period.

Linkage Method: Click Linkage Method and check the checkbox to select the linkage method. Audible warning, notify surveillance center, send email, upload to FTP, trigger channel and trigger alarm output are selectable. You can specify the linkage method when an event occurs.

3. Click **Save** to save the settings.

After the settings, you can view the current temperature and humidity on the top of this interface.



5.4.4 Search History Temperature

Purpose:

Search the history temperature and generate the temperature/time graphic.

Steps:

1. Select the camera channel, preset point, rule and display time interval from the drop-down list.
2. Set the start time.
3. Click **Search** button to generate the graphic.
4. Click **Export** to download the graphic.

Figure 5-31 History Temperature Graphic Configuration

5.4.5 VCA Rule Display

Purpose:

You can customize the VCA rule display information format.

Step:

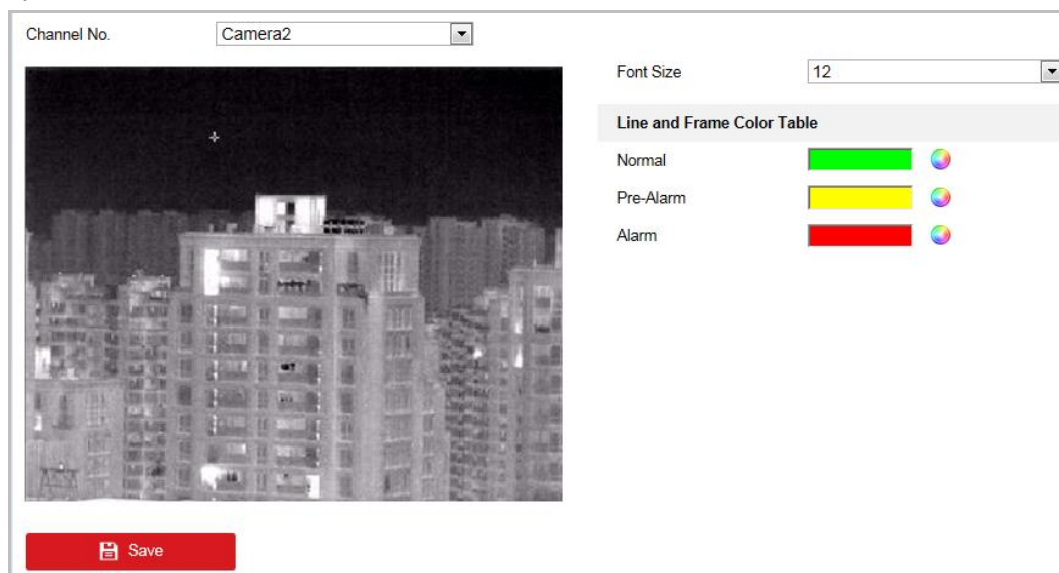



Figure 5-32 VCA Rule Display

1. Set the font size of the VCA rules.
2. Customize the color of line and frame for Normal, Pre-Alarm, and Alarm.
3. Click  to save the settings.

Chapter 6 VCA Configuration

Before you start:

Go to **Configuration > System > Maintenance > VCA Resource Type** and select the VCA Resource as **Temperature Measurement + Behavior Analysis**.

Purpose:

You can do intelligent analysis, such as behavior analysis, with the positioning system. Multiple rules can be configured for different requirements.



The VCA (Video Content Analysis) function only supported by the thermal channel.

6.1 Configuring VCA Information

Steps:

1. Enter the VCA Information Configuration interface:
Configuration > VCA Configuration > VCA Info.

Overlay & Capture

Intelligent Analysis

Display on Stream

Display VCA Info. on Stream

Display on Picture

Display Target Info. on Alarm Picture

Display Rule Info. on Alarm Picture

Snapshot Settings

Upload JPEG Image to Center

Picture Quality

Figure 6-1 VCA Information

2. Check the checkbox to enable the Intelligent Analysis. And you can view the current version for the behavior analysis.
3. Set the display information:
If you select to display the target info and rule info on the alarm picture are supported; you can enable the functions by ticking the corresponding checkbox on your demand.
And if you tick the checkbox of display target info and rule on stream, the information will be added to the video stream, and the overlay will be displayed if you get live view or play back by the VS Player.
4. Set the Snapshot:

You can configure the **Notify Surveillance Center** function which is used for uploading the picture to the surveillance center when and VCA alarm occurs. You can also set the quality and resolution of the picture separately.

- Click  to save the settings.

6.2 Advanced Configuration

All the parameters for both behavior analysis and face capture are collected in the advanced configuration page. You can configure these parameters for different VCA types on your demand.

Steps:

- Enter the Advanced Configuration interface:
Configuration > VCA > Advanced Configuration

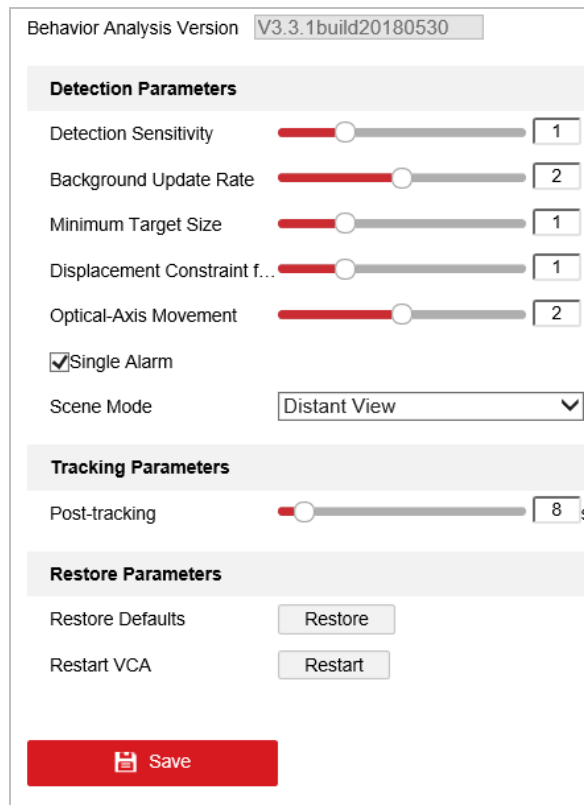

Behavior Analysis Version V3.3.1build20180530

Detection Parameters

Detection Sensitivity 1

Background Update Rate 2

Minimum Target Size 1

Displacement Constraint f... 1

Optical-Axis Movement 2

Single Alarm

Scene Mode Distant View

Tracking Parameters

Post-tracking 8 s

Restore Parameters

Restore Defaults

Restart VCA

Figure 6-2 Advanced Configuration

- Adjust the Detection Parameters.

Detection Sensitivity: Range [0-4], the higher the sensitivity is, the easier the target will be detected.

Background Update Rate: Range [0-4], if a detected target remains in the monitoring scene for a certain time, the system will count the target as the background automatically. The greater the value is, the faster the target will be counted as the background.

Minimum Target Size: Range [0-4], The system will filter out the object smaller than

the minimum target size.

Displacement Constraint for Target Generation: Range [0-4], the higher the value is, the slower the target is generated, and the higher accuracy the analysis will get.

Scene Modes: The scene mode is set to be General by default. Select Distant View when you are far from the targets. Select Indoor when you are indoor.

Optical-axis Movement: Check the checkbox when the target moves in the direction of camera's optical -axis.

Single Alarm: You can enable Single Alarm, and the system only sends alarm once for one target triggering. Otherwise, the alarm will be triggered continuously until the target disappears.

3. Adjust the Tracking Parameters.

Post-Tracking: Range [2-600], you can configure the tracking duration after the target is still.

Restore Default: Click **Restore** to restore the parameters to the default.

Restart VCA: Click **Restart** to restart the VCA function.

6.3 Behavior Analysis

Purpose:

The positioning system supports patrol tracking for multiple scenes. At most 8 rules can be configured for a single scene. You can configure the rules for the scene on your demand.

Steps:

1. Configure the **VCA Info**: For details, see 7.2 Configuring VCA Information.
2. Configure the **Zooming Ratio** parameters: Set the appropriate tracking zooming ratio

with the PTZ control panel. Click on  to save the settings.

The optical camera will track the target when the VCA rule is triggered which is configured on the thermal camera.

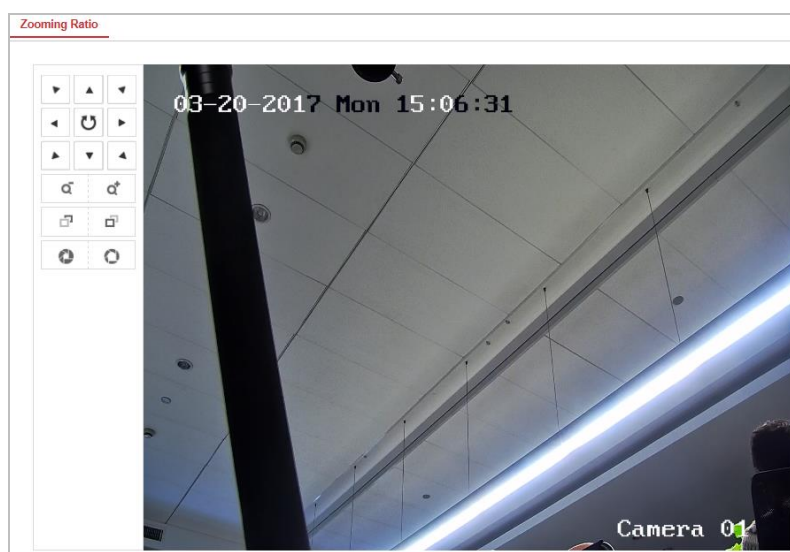

Figure 6-3 Zoom Ratio

3. Configure the Scene:

Go to **VCA > Scene Parameters**

At most 10 scenes can be added. Different rules and properties can be configured for each scene.

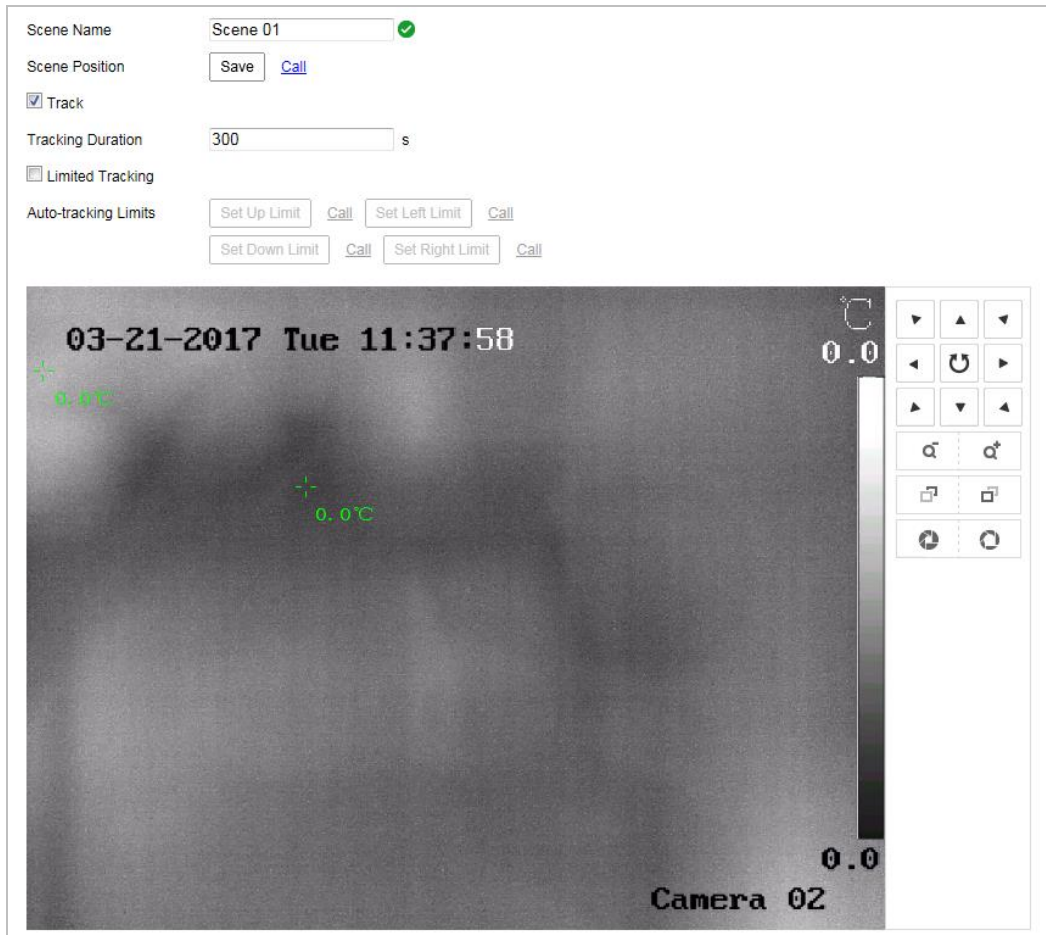

Figure 6-4 Scene Parameters

Create a Scene:

- 1) Add New Scene: Click **New Scene** to create a new scene.
- 2) Control the PTZ to get the required scene.
- 3) Set the scene parameters:

Scene Name: Enter a custom scene name.

Patrol Sequence: Set the sequence for the scene when doing patrol tracking. If the sequence is selected as 0, this scene will not be configured for patrol tracking.

Duration: Set the dwell time of the scene when doing patrol tracking. The intelligent analysis will be enabled during the period. If the alarm is triggered, the positioning system will start to track automatically.

Enable Track: Check the checkbox to enable the tracking function for the scene.

Tracking Duration: Set the duration of the tracking. If the value is selected as 0, the tracking duration will not be limited.

Limited Tracking: You can check the checkbox to enable/disable the function. If the function is enabled, you can set the limited position for the tracking.

- 4) Click  to save the settings.

Rule Configuration:

At most 8 rules can be configured for a single scene. Follow the steps below to configure the rule for the scene.

- 1) Click the **Rule** tab to enter the rule settings interface.
- 2) Create new rule: Click on the button  to add a new rule.
- 3) Select rule type: Click the dropdown menu to select the rule type. Line Crossing, Intrusion, Region Entrance, and Region Exiting are selectable.

Enable	No.	Rule Name	Rule Type
<input checked="" type="checkbox"/>	1	RULE1	Intrusion

Filter by Pixel ▼

Duration 1 s ✓

Max. Size 0 * 0 (W*H)
 Sensitivity 50 ✓

Min. Size 0 * 0 (W*H)
 Detection Target All ▼

Figure 6-5 Rule List

- 4) Configure the rule area: Click the Draw Line or Draw Area button on the tool bar of the live view panel. Click the mouse on the live view panel. Right click the mouse to finish drawing. For details, see *6.4 Rule Configuration Demonstration*.
- 5) Configure the filtering size: The filtering function is supported for all rules. You can set the minimum and maximum size of the object needs to be filtered. The system will only detect the object in a size between the configured minimum and maximum value. For details, see *6.4 Rule Configuration Demonstration*.
- 6) Configure the Duration: Set the dwell time of the target cross the line or area. The intelligent analysis will be enabled during the period.
- 7) Configure the Sensitivity: The higher the value is, more easily the alarm will be triggered.
- 8) Configure the Detection Target.
- 9) Enable rules: Check the **Enable** checkbox of each rule in the rule list to enable the rule.
- 10) Click  to save the settings.



Create multiple rules: You can create more rules by repeating the above steps.

Configure Arming schedule:

- 1) Click the Arming Schedule tab.
- 2) Select a rule from the rule list.

Rule List		
No.	Rule Name	Rule Type
1	RULE1	Intrusion

Normal Linkage	Trigger Alarm Output	Trigger Recording
<input type="checkbox"/> Send Email	<input type="checkbox"/> A->1	<input type="checkbox"/> A1
<input checked="" type="checkbox"/> Notify Surveillance Center	<input type="checkbox"/> A->2	<input type="checkbox"/> A2

Figure 6-6 Arming Schedule

- 3) Click on the Edit button to edit the arming time segment.

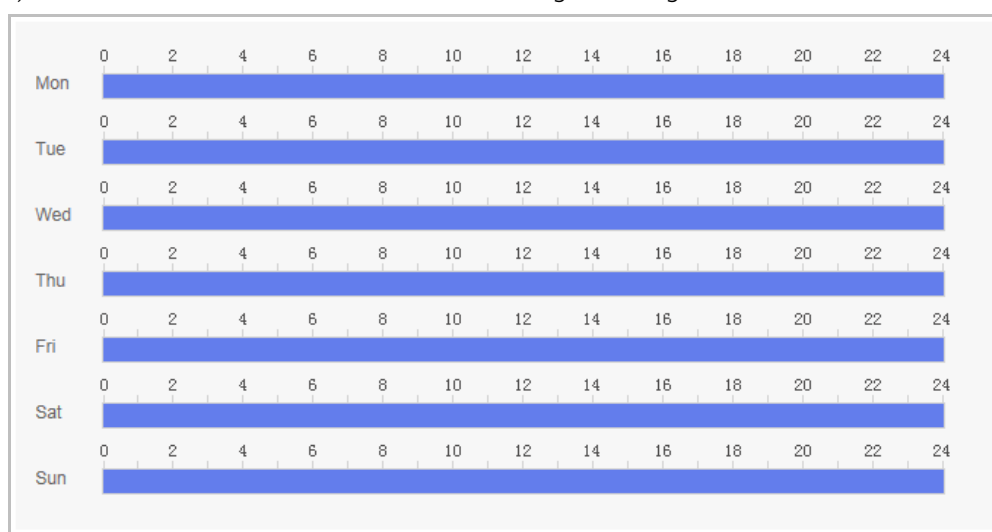

Figure 6-7 Schedule Time



You can select to copy the settings to whole week or are specific days of the week. At most 8 segments can be configured.

- 4) Click  to save the settings.

Configure Arming schedule:

- 1) Click the Alarm Linkage tab.

- 2) Select a rule from the rule list.

Rule List		
No.	Rule Name	Rule Type
1	RULE1	Intrusion

<input type="checkbox"/> Normal Linkage	<input type="checkbox"/> Trigger Alarm Output	<input type="checkbox"/> Trigger Recording
<input type="checkbox"/> Send Email	<input type="checkbox"/> A->1	<input type="checkbox"/> A1
<input checked="" type="checkbox"/> Notify Surveillance Center	<input type="checkbox"/> A->2	<input type="checkbox"/> A2

Figure 6-8 Alarm Linkage

- 3) Check the checkbox of corresponding linkage actions to enable it.
4. Advanced Configuration: For details, see [section 6.2 Advanced Configuration](#). Click

 Save to save the settings.

6.4 Rule Configuration Demonstration

Purpose:

This section provides detailed configuration steps for each rule.

6.4.1 Line Crossing

Purpose:

This function can be used for detecting people, vehicles and objects traversing a set virtual plane. The traversing direction can be set as bidirectional, from left to right or from right to left. The alarm will be triggered if the rule is broken.

Steps:

1. Create new rule: Click on the button  to add a new rule.
2. Select rule type: Click the dropdown menu and select **Line Crossing** as the rule type.

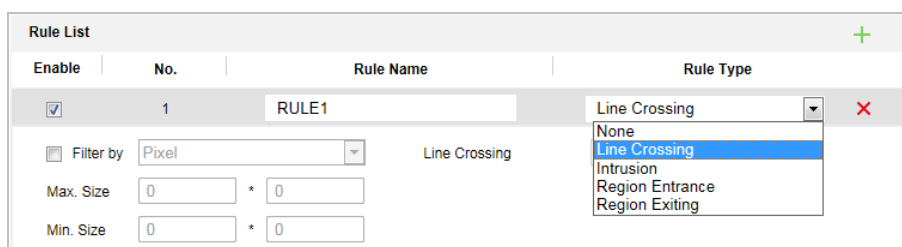





Figure 6-9 Select Rule Type

3. (Optional) Configure the size filter, if you want to narrow the detection target to a desired range.
 - a. Check the checkbox of the **Filter by**, and only filter by pixel is available.
 - b. Click the  button and draw a rectangle on the live view image as the Min. size filter.
 - c. Click the  button and draw a rectangle on the live view image as the Max. size filter.
4. Configure the rule area:

Click  on the tool bar of the live view panel. Specify a point of the line by clicking the mouse on the live view image, and then specify the other one.

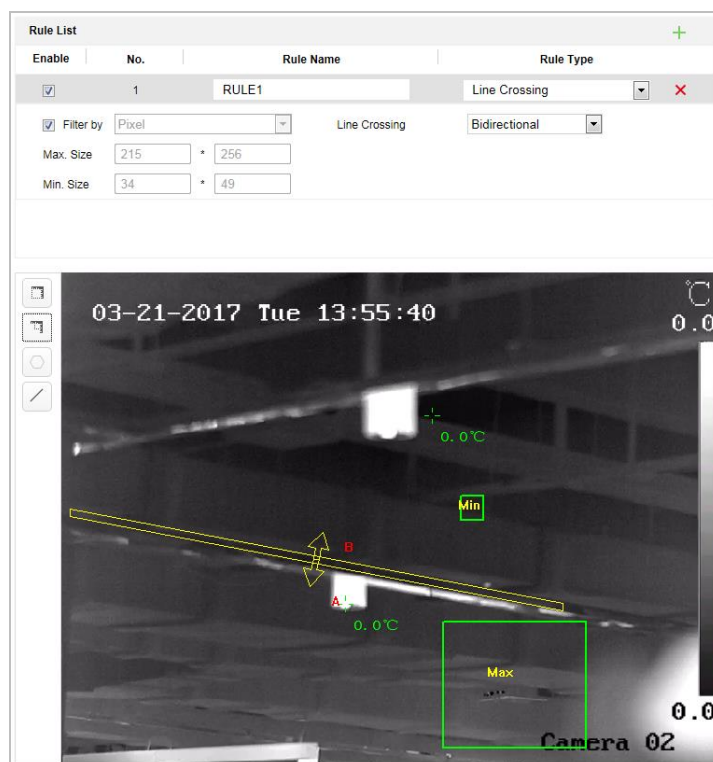



Figure 6-10 Draw Line

5. Click the dropdown menu in the rule list to select the crossing direction.
6. Enable rules: Check the **Enable** checkbox of each rule in the rule list to enable the rule.
7. Click  to save the settings.

6.4.2 Intrusion

Purpose:

This function can be used for detecting whether there are people, vehicles and objects intrude into the pre-defined region longer than the set duration. The alarm will be triggered if the rule is broken.

Steps:

1. Create new rule: Click on the button  to add a new rule.
2. Select rule type: Click the dropdown menu and select **Intrusion** as the rule type.
3. Configure the filtering size: for details, see step 3 in **section 6.4.1 Line Crossing**.
4. Configure the rule area:



Click  on the tool bar of the live view panel. Click the mouse on the live view image to specify a corner of the area. After you specify all the corners, right click the mouse to connect the first corner and the last corner, which means the polygonal area is drawn.



Figure 6-11 Draw Area



5. Set the duration from 1 to 100.
6. Enable rules: Check the **Enable** checkbox of each rule in the rule list to enable the rule.
7. Click  to save the settings.

6.4.3 Region Entrance

Purpose:

This function can be used for detecting people, vehicles and objects entering the pre-defined region. The alarm will be triggered if the rule is broken.

Steps:

1. Create new rule: Click on the button  to add a new rule.
2. Select rule type: Click the dropdown menu and select **Region Entrance** as the rule type.
3. Configure the rule area:
Click  on the tool bar of the live view panel. Click the mouse on the live view panel.
Right click the mouse to finish drawing.
4. Configure the filtering size: for details, see step 3 in **section 6.4.1 Line Crossing**.
5. Enable rules: Check the **Enable** checkbox of each rule in the rule list to enable the rule.
6. Click  to save the settings.

6.4.4 Region Exiting

Purpose:

This function can be used for detecting people, vehicles and objects exiting the pre-defined region. The alarm will be triggered if the rule is broken.

Steps:



1. Create new rule: Click on the button  to add a new rule.
2. Select rule type: Click the dropdown menu and select **Region Exiting** as the rule type.
3. Configure the rule area:
Click  on the tool bar of the live view panel. Click the mouse on the live view panel.
Right click the mouse to finish drawing.



Figure 6-12 Draw Area

4. Configure the filtering size: for details, see step 3 in *section 6.4.1 Line Crossing*.
5. Enable rules: Check the **Enable** checkbox of each rule in the rule list to enable the rule.
6. Click  to save the settings.

Chapter 7 Positioning System Configuration

7.1 Configuring Network Settings



The functions vary depending on the models of positioning system.

7.1.1 Basic Settings

Configuring TCP/IP Settings

Purpose:

TCP/IP settings must be properly configured before you operate the positioning system over network. IPv4 and IPv6 are both supported.

Steps:

1. Enter TCP/IP settings interface:
Configuration > Network > Basic Settings > TCP/IP

TCP/IP		DDNS	PPPoE	Port	NAT
NIC Type	Auto				
	<input checked="" type="checkbox"/> DHCP				
IPv4 Address	10.16.1.250				
IPv4 Subnet Mask	255.255.255.0				
IPv4 Default Gateway	10.16.1.254				
IPv6 Mode	Route Advertisement				
IPv6 Address	::				
IPv6 Subnet Mask	0				
IPv6 Default Gateway	::				
Mac Address	c0:56:e3:b3:bc:c0				
MTU	1500				
Multicast Address					
	<input checked="" type="checkbox"/> Enable Multicast Discovery				
DNS Server					
Preferred DNS Server	8.8.8.8				
Alternate DNS Server					

Figure 7-1 TCP/IP Settings

- Configure the NIC settings, including the IPv4(IPv6) Address, IPv4(IPv6) Subnet Mask and IPv4(IPv6) Default Gateway.
- Click  to save the above settings.

You can click **Test** to make sure that the IP address is valid.



If the DHCP server is available, you can check DHCP to automatically obtain an IP address and other network settings from that server.

The valid value range of Maximum Transmission Unit (MTU) is 500 ~ 1500. The default value is 1500.

The Multicast sends a stream to the multicast group address and allows multiple clients to acquire the stream at the same time by requesting a copy from the multicast group address.

Before utilizing this function, you have to enable the Multicast function of your router and configure the gateway of the network positioning system.

If the DNS server settings are required for some applications (e.g., sending email), you should properly configure the **Preferred DNS Server** and **Alternate DNS server**.

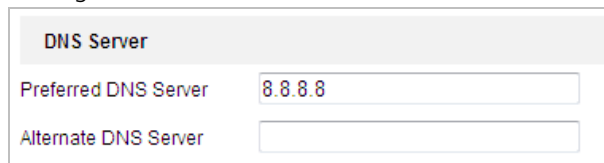

The screenshot shows a form titled "DNS Server" with two input fields. The "Preferred DNS Server" field contains the value "8.8.8.8". The "Alternate DNS Server" field is empty.

Figure 7-2 DNS Server Settings



The router must support the route advertisement function if you select **Route Advertisement** as the IPv6 mode.

Configuring DDNS Settings

Purpose:

If your positioning system is set to use PPPoE as its default network connection, you can use the Dynamic DNS (DDNS) for network access.

Before you start:

Registration on the DDNS server is required before configuring the DDNS settings of the positioning system.



For your privacy and to better protect your system against security risks, we strongly recommend the use of strong passwords for all functions and network devices. The password should be something of your own choosing (using a minimum of 8 characters, including upper case letters, lower case letters, numbers and special characters) in order to increase the security of your product.

Proper configuration of all passwords and other security settings is the responsibility of the installer and/or end-user.

Steps:

1. Enter the DDNS settings interface:

Configuration > Network > Basic Settings > DDNS

Figure 7-3 DDNS Settings

2. Check the **Enable DDNS** checkbox to enable this feature.
3. Select **DDNS Type**. Three DDNS types are selectable: IP Server, HiDDNS, NO-IP and DynDNS.

DynDNS:

Steps:

- (1) Enter **Server Address** of DynDNS (e.g. members.dyndns.org).
- (2) In the **Domain** text field, enter the domain name obtained from the DynDNS website.
- (3) Enter the **Port** of DynDNS server.
- (4) Enter the **User Name** and **Password** registered on the DynDNS website.
- (5) Click  to save the settings.

Figure 7-4 DynDNS Settings

IP Server:

Steps:

- (1) Enter the Server Address of the IP Server.

(2) Click  to save the settings.



The **Server Address** should be entered with the static IP address of the computer that runs the IP Server software. For the IP Server, you have to apply a static IP, subnet mask, gateway and preferred DNS from the ISP.

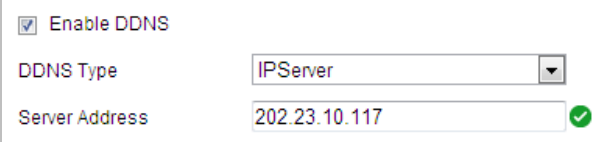

The screenshot shows the IP Server Settings interface. It includes a checked checkbox for 'Enable DDNS'. Below it, the 'DDNS Type' is set to 'IPServer' in a dropdown menu. The 'Server Address' field contains the IP address '202.23.10.117' and has a green checkmark icon to its right.

Figure 7-5 IP Server Settings

HiDDNS:

Steps:

- (1) Enter the Server Address.
- (2) Enter the Domain name of the camera. The domain is the same with the device alias in the HiDDNS server.
- (3) Click  to save the settings.

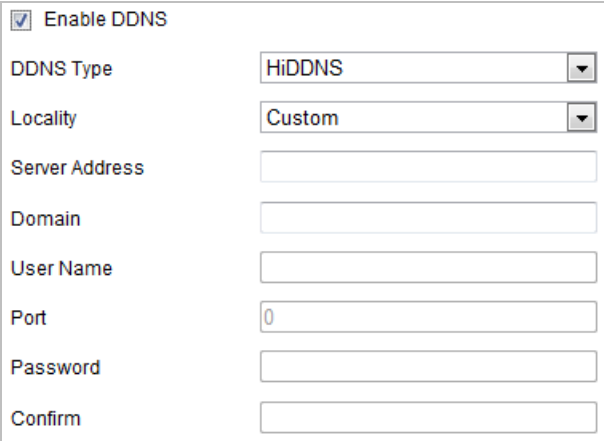

The screenshot shows the HiDDNS Settings interface. It includes a checked checkbox for 'Enable DDNS'. Below it, the 'DDNS Type' is set to 'HiDDNS' in a dropdown menu. The 'Locality' is set to 'Custom' in another dropdown menu. There are several text input fields: 'Server Address', 'Domain', 'User Name', 'Port' (containing '0'), 'Password', and 'Confirm'.

Figure 7-6 HiDDNS Settings

NO-IP:

Steps:

- (1) Enter **Server Address** of NO-IP.
- (2) In the **Domain** text field, enter the domain name obtained from the NO-IP website.
- (3) Enter the **Port** of NO-IP server.
- (4) Enter the **User Name** and **Password** registered on the NO-IP website.
- (5) Click  to save the settings.

Configuring PPPoE Settings

Purpose:

If you have no router but only a modem, you can use Point-to-Point Protocol over Ethernet (PPPoE) function.

Steps:

1. Enter the PPPoE settings interface:

Configuration > Network > Basic Settings > PPPoE



<input checked="" type="checkbox"/> Enable PPPoE	
Dynamic IP	0.0.0.0
User Name	
Password	
Confirm	

Figure 7-7 PPPoE Settings

2. Check the **Enable PPPoE** checkbox to enable this feature.
3. Enter **User Name**, **Password**, and **Confirm** password for PPPoE access.



The User Name and Password should be assigned by your ISP.



For your privacy and to better protect your system against security risks, we strongly recommend the use of strong passwords for all functions and network devices. The password should be something of your own choosing (using a minimum of 8 characters, including upper case letters, lower case letters, numbers and special characters) in order to increase the security of your product. Proper configuration of all passwords and other security settings is the responsibility of the installer and/or end-user.

4. Click  to save and exit the interface.

Configuring Port Settings

Purpose:

If there is a router and you want to access the positioning system through Wide Area Network (WAN), you need to forward the 3 ports for the positioning system.

Steps:

1. Enter the Port settings interface:

Configuration > Network > Basic Settings > Port

HTTP Port	80
RTSP Port	554
HTTPS Port	443
Server Port	8000

Figure 7-8 Port Settings

- Set the HTTP port, RTSP port and port of the positioning system.

HTTP Port: The default port number is 80.

RTSP Port: The default port number is 554.

HTTPS Port: The default port number is 443.

Server Port: The default port number is 8000.

- Click  to save the settings.

Configuring NAT (Network Address Translation) Settings

Purpose:

Universal Plug and Play (UPnP™) is a networking architecture that provides compatibility among networking equipment, software and other hardware devices. The UPnP protocol allows devices to connect seamlessly and to simplify the implementation of networks in the house and corporate environments.

With the function enabled, you don't need to configure the port mapping for each port, and the camera is connected to the Wide Area Network via the router.

Steps:

- Enter the UPnP™ settings interface.
Configuration > Network > Basic Settings > NAT
- Check the checkbox to enable the UPnP™ function.



You can edit the Friendly Name of the positioning system. This name can be detected by corresponding device, such as a router.

- Set the port mapping mode:

To port mapping with the default port numbers:

Choose **Port Mapping Mode**

To port mapping with the customized port numbers:

Choose **Port Mapping Mode**

And you can customize the value of the port number by yourself.

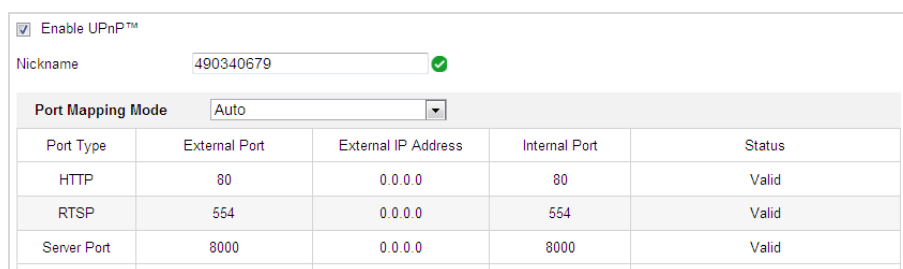

Port Mapping Mode				
Port Type	External Port	External IP Address	Internal Port	Status
HTTP	80	0.0.0.0	80	Valid
RTSP	554	0.0.0.0	554	Valid
Server Port	8000	0.0.0.0	8000	Valid

Figure 7-9 Port Mapping Mode

- Click  to save the settings.

7.1.2 Advanced Settings

Configuring SNMP Settings

Purpose:

You can use SNMP to get positioning system status and parameters related information.

Before you start:

Before setting the SNMP, please use the SNMP software and manage to receive the positioning system information via SNMP port. By setting the Trap Address, the positioning system can send the alarm event and exception messages to the surveillance center.



The SNMP version you select should be the same as that of the SNMP software.

Steps:

- Enter the SNMP settings interface:
Configuration > Network > Advanced Settings > SNMP

Figure 7-10 SNMP Settings

2. Check the corresponding version checkbox (**Enable SNMP v1**, **Enable SNMP v2c**, **Enable SNMP v3**) to enable the feature.
3. Configure the SNMP settings.



The configuration of the SNMP software should be the same as the settings you configure here.

4. Click  to save and finish the settings.

Configuring FTP Settings

Purpose:

You can set a FTP server and configure the following parameters for uploading captured pictures.

Steps:

1. Enter the FTP settings interface:
Configuration > Network > Advanced Settings > FTP

Figure 7-11 FTP Settings

2. Configure the FTP settings, including server address, port, user name, password, directory, and upload type.



The server address supports both the domain name and IP address formats.



For your privacy and to better protect your system against security risks, we strongly recommend the use of strong passwords for all functions and network devices. The password should be something of your own choosing (using a minimum of 8 characters, including upper case letters, lower case letters, numbers and special characters) in order to increase the security of your product.

Proper configuration of all passwords and other security settings is the responsibility of the installer and/or end-user.

Setting the directory in FTP server for saving files:

In the **Directory Structure** field, you can select the root directory, parent directory and child directory.

Root directory: The files will be saved in the root of FTP server.

Parent directory: The files will be saved in a folder in FTP server. The name of folder can be defined as shown in following Figure 7-12.

Figure 7-12 Parent Directory

Child directory: It is a sub-folder which can be created in the parent directory. The files will be saved in a sub-folder in FTP server. The name of folder can be defined as shown in following Figure 7-13.

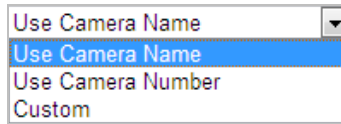

Figure 7-13 Child Directory

Upload type: To enable uploading the captured picture to the FTP server.

- Click  to save the settings.
- You can click **Test** to confirm the configuration.



If you want to upload the captured pictures to FTP server, you also have to enable the continuous snapshot or event-triggered snapshot in **Snapshot** interface.

Configuring Email Settings

Purpose:

The system can be configured to send an Email notification to all designated receivers if an alarm event is detected, e.g., motion detection event, video loss, video-tampering, etc.

Before you start:

Please configure the DNS Server settings under **Configuration > Network > Basic Settings > TCP/IP** before using the Email function.

Steps:

- Enter the Email settings interface:

Configuration > Network > Advanced Settings > Email

Sender	<input type="text"/>
Sender's Address	<input type="text"/>
SMTP Server	<input type="text"/>
SMTP Port	25
E-mail Encryption	None
<input type="checkbox"/> Attached Image	
Interval	2 s
<input type="checkbox"/> Authentication	
User Name	<input type="text"/>
Password	<input type="text"/>
Confirm	<input type="text"/>

Receiver			
No.	Receiver	Receiver's Address	Test
1			<input type="button" value="Test"/>
2			
3			

Figure 7-14 Email Settings

- Configure the following settings:

Sender: The name of the email sender.

Sender's Address: The email address of the sender.

SMTP Server: The SMTP Server IP address or host name (e.g., smtp.263xmail.com).

SMTP Port: The SMTP port. The default TCP/IP port for SMTP is 25.

E-mail encryption: None, SSL, and TLS are selectable. When you select SSL or TLS and disable STARTTLS, e-mails will be sent after encrypted by SSL or TLS. The SMTP port should be set as 465 for this encryption method. When you select SSL or TLS and enable STARTTLS, emails will be sent after encrypted by STARTTLS, and the SMTP port should be set as 25.



STARTTLS protocol must be supported by the email server for e-mail encryption with STARTTLS. When it is not supported by the email server and the checkbox of Enable STARTTLS is checked, the email will not be encrypted.

Attached Image: Check the checkbox of **Attached Image** if you want to send emails with attached alarm images.

Interval: The interval refers to the time between two actions of sending attached pictures.

Authentication (optional): If your email server requires authentication, check this checkbox to use authentication to log in to this server and enter the login user name and password.



For your privacy and to better protect your system against security risks, we strongly recommend the use of strong passwords for all functions and network devices. The password should be something of your own choosing (using a minimum of 8 characters, including upper case letters, lower case letters, numbers and special characters) in order to increase the security of your product.

Proper configuration of all passwords and other security settings is the responsibility of the installer and/or end-user.

Receiver: Select the receiver to which the email is sent. Up to 2 receivers can be configured.

Receiver: The name of the user to be notified.

Receiver's Address: The email address of user to be notified. (Optional: click **Test** to make sure that the email server can send email out.)

3. Click  to save the settings.

Configuring Platform Access

Purpose:

Platform access provides you an option to manage the devices via platform.

Steps:

1. Enter the Platform Access interface.
Configuration > Network > Advanced Settings > Platform Access

Figure 7-15 Platform Access Settings

2. Check the checkbox of **Enable** to enable the platform access function of the device.
3. Select the Platform Access Mode from the dropdown list.
4. Set the Server IP.
5. Click  to save the settings

Configuring HTTPS Settings

Purpose:

HTTPS is consisted by SSL&HTTP. It is used for encryption transmission, identity authentication network protocol which enhances the security of WEB accessing.



For your privacy and to better protect your system against security risks, we strongly recommend the use of strong passwords for all functions and network devices. The password should be something of your own choosing (using a minimum of 8 characters, including upper case letters, lower case letters, numbers and special characters) in order to increase the security of your product.

Proper configuration of all passwords and other security settings is the responsibility of the installer and/or end-user.

Steps:

1. Enter the HTTPS settings interface.
Configuration > Network > Advanced Settings > HTTPS
2. Create the self-signed certificate or authorized certificate.

Figure 7-16 Create Certificate

OPTION 1: Create the self-signed certificate

- 1) Select Create Self-signed Certificate.
- 2) Click **Create** to create the following dialog box.

Figure 7-17 Create Self-signed Certificate

- 3) Enter the country, host name/IP, validity and other information.
- 4) Click **OK** to save the settings.

OPTION 2: Start the installation when signed certificate is available.

- 1) Select Signed certificate is available, Start the installation directly.
- 2) Click **Browse** to upload the available certificate.
- 3) Click **Install** button to install the certificate.
- 4) Click **OK** to save the settings.

OPTION 3: Create certificate request first and continue the installation.

- 1) Select Create certificate request first and continue the installation.
 - 2) Click **Create** to create the certificate request, and fulfill the required information.
 - 3) Download the certificate request and submit it to the trusted certificate authority for signature.
 - 4) After receiving the signed valid certificate, import the certificate to the device.
 - 5) Click **OK** to save the settings.
3. There will be the certificate information after you successfully create and install the certificate.

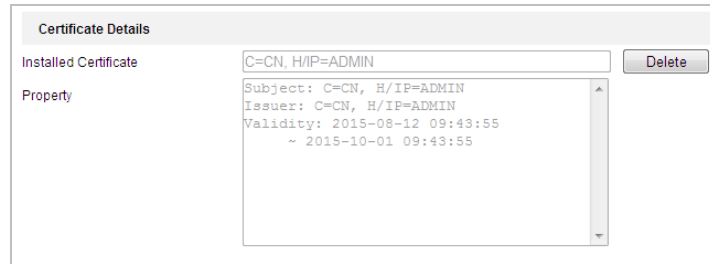

Figure 7-18 Installed Certificate Property



The default port number of HTTPS is 443. The port value ranges from 1 to 65535. When the port number is the default number 443, the format of the URL is **https://IP address**, eg., https://192.168.1.64. When the port number is not the default number 443, the format of the URL is **https://IP address:port number**, eg., https://192.168.1.64:81.

Configuring QoS Settings

Purpose:

QoS (Quality of Service) can help solve the network delay and network congestion by configuring the priority of data sending.

Steps:

1. Enter the QoS settings interface:

Configuration > Advanced Configuration > Network > QoS

 A screenshot of the "QoS Settings" web interface. It displays three rows of settings, each with a label and a text input field containing the value "0":

Video/Audio DSCP	0
Event/Alarm DSCP	0
Management DSCP	0

Figure 7-19 QoS Settings

2. Configure the QoS settings, including video / audio DSCP, event / alarm DSCP and Management DSCP.

The valid DSCP value ranges from 0 to 63. The DSCP value is bigger, the priority is higher.

3. Click  to save the settings.



Make sure that you enable the QoS function of your network device (such as a router). It will ask for a reboot for the settings to take effect.

Configuring 802.1X Settings

Purpose:

The positioning system supports IEEE 802.1X standard.

IEEE 802.1X is a port-based network access control. It enhances the security level of the LAN. When devices connect to this network with IEEE 802.1X standard, the authentication is needed. If the authentication fails, the devices don't connect to the network.

The protected LAN with 802.1X standard is shown as follows:

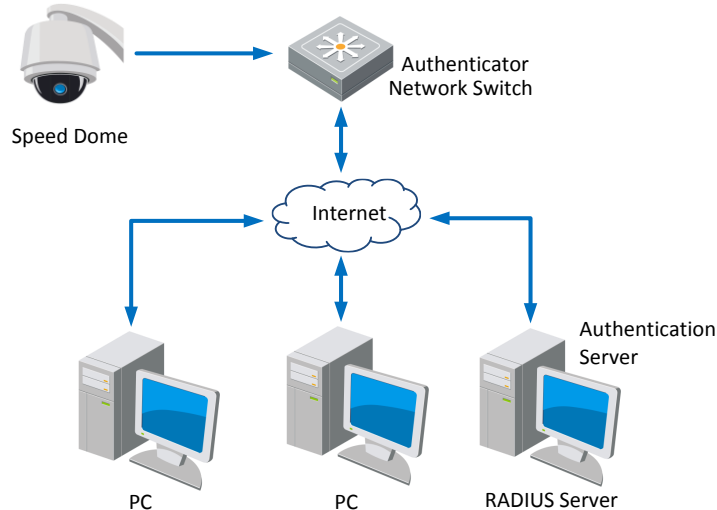

Figure 7-20 Protected LAN

Before connecting the Network Camera to the protected LAN, please apply a digital certificate from a Certificate Authority.

The network camera requests access to the protected LAN via the authenticator (a switch).

The switch forwards the identity and password to the authentication server (RADIUS server).

The switch forwards the certificate of authentication server to the network camera.

If all the information is validated, the switch allows the network access to the protected network.



For your privacy and to better protect your system against security risks, we strongly recommend the use of strong passwords for all functions and network devices. The password should be something of your own choosing (using a minimum of 8 characters, including upper case letters, lower case letters, numbers and special characters) in order to increase the security of your product.

Proper configuration of all passwords and other security settings is the responsibility of the installer and/or end-user.

Steps:

1. Connect the network camera to your PC directly with a network cable.
2. Enter the 802.1X settings interface:

Configuration > Network > Advanced Settings > 802.1X

Figure 7-21 802.1X Settings

3. Check the **Enable IEEE 802.1X** checkbox to enable it.
4. Configure the 802.1X settings, including user name and password.



The EAP-MD5 version must be identical with that of the router or the switch.

5. Click  to finish the settings.



The camera reboots when you save the settings.

6. After the configuration, connect the camera to the protected network.

Integration Protocol

Purpose:

If you need to access to the camera through the third party platform, you can enable CGI function. And if you need to access to the device through ONVIF protocol, you can configure ONVIF user in this interface. Refer to ONVIF standard for detailed configuration rules.

CGI

Check the **Enable Hikvision_CGI** checkbox and then select the authentication from the drop-down list.

Note: Digest is the recommended authentication method.

ONVIF

Steps:

1. Check the Enable ONVIF checkbox to enable the function.
2. Add ONVIF users. Up to 32 users are allowed.
3. Set the user name and password, and confirm the password. You can set the user as media user, operator, and administrator.

Note: ONVIF user account is different from the camera user account. You have set ONVIF user account independently.

4. 3. Save the settings.

Note: User settings of ONVIF are cleared when you restore the camera.

7.2 Configuring Video and Audio Settings

7.2.1 Configuring Video Settings

Steps:

1. Enter the Video settings interface:

Configuration > Video/Audio > Video

Channel No.	Camera 01	▼
Stream Type	Main Stream(Normal)	▼
Video Type	Video Stream	▼
Resolution	1920*1080P	▼
Bitrate Type	Variable	▼
Video Quality	Medium	▼
Frame Rate	25	▼ fps
Max. Bitrate	4096	Kbps
Video Encoding	H.264	▼
H.264+	OFF	▼
Profile	High Profile	▼
I Frame Interval	50	
SVC	OFF	▼
Smoothing	<input type="range" value="50"/>	50 [Clear<->Smooth]
<input type="button" value="Copy to..."/> <input type="button" value="Save"/>		

Figure 7-22 Configure Video Settings

2. Select the **Channel No.** in the dropdown list you want to configure.
3. Select the **Stream Type** of the positioning system to main stream (normal), sub-stream or third stream. The main stream is usually for recording and live viewing with good bandwidth, and the sub-stream can be used for live viewing when the bandwidth is limited. Refer to the *Section 4.1 Configuring Local Parameters* for switching the main stream and sub-stream for live viewing.
4. You can customize the following parameters for the selected stream.



The parameters vary depending on the models of the positioning system.

Video Type:

Select the stream type to video stream, or video & audio composite stream. The audio signal will be recorded only when the **Video Type** is **Video & Audio**.

Resolution:

Select the resolution of the video output.

Bitrate Type:

Select the bitrate type to constant or variable.

Video Quality:

When bitrate type is selected as **Variable**, 6 levels of video quality are selectable.

Frame Rate:

The frame rate is to describe the frequency at which the video stream is updated and it is measured by frames per second (fps). A higher frame rate is advantageous when there is movement in the video stream, as it maintains image quality throughout.

Max. Bitrate:

Set the max. bitrate to 256~16384Kbps. The higher value corresponds to the higher video quality, but the higher bandwidth is required.

Video Encoding:

The **Video Encoding** standard can be set to H.264 or H.265.

H.264+ and H.265+:

- **H.264+:** If you set the main stream as the stream type, and H.264 as the video encoding, you can see H.264+ available. H.264+ is an improved compression coding technology based on H.264. By enabling H.264+, users can estimate the HDD consumption by its maximum average bitrate. Compared to H.264, H.264+ reduces storage by up to 50% with the same maximum bitrate in most scenes.
- **H.265+:** If you set the main stream as the stream type, and H.265 as the video encoding, you can see H.265+ available. H.265+ is an improved compression coding technology based on H.265. By enabling H.265+, users can estimate the HDD consumption by its maximum average bitrate. Compared to H.265, H.265+ reduces storage by up to 50% with the same maximum bitrate in most scenes.

You need to reboot the camera if you want to turn on or turn off the H.264+/H.265+. If you switch from H.264+ to H.265+ directly, and vice versa, a reboot is not required by the system.

Notes:

- Upgrade your video player to the latest version if live view or playback does not work properly due to compatibility.
- With H.264+/H.265+ enabled, the parameters such as profile, I frame interval, video quality, and SVC are greyed out if the bitrate type is variable.
- With H.264+/H.265+ enabled, some functions are not supported. For those functions, corresponding interfaces will be hidden.
- H.264+/H.265+ can spontaneously adjust the bitrate distribution according the requirements of the actual scene in order to realize the set maximum average bitrate in the long term. The camera needs at least 24 hours to adapt to a fixed monitoring scene.

Profile:

Basic Profile, Main Profile and High Profile are selectable.

I Frame Interval:

Set the I-Frame interval from 1 to 400.

SVC:

Scalable Video Coding is an extension of the H.264/AVC standard. Select OFF/ON to disable/enable the SVC function. Select Auto, and the device will automatically extract

frames from the original video when the network bandwidth is insufficient.

Smoothing:

It refers to the smoothness of the stream. The higher value of the smoothing, the better fluency of the stream, though, the video quality may not be so satisfied. The lower value of the smoothing, the higher quality of the stream, though it may appear not fluent.

5. Click  to save the settings.

7.2.2 Configuring Audio Settings

Steps:

1. Enter the Audio settings interface
Configuration > Video/Audio > Audio
2. Select the channel No. from the dropdown list.

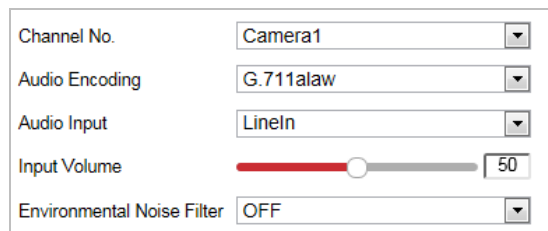

Channel No.	Camera1
Audio Encoding	G.711alaw
Audio Input	Lineln
Input Volume	50
Environmental Noise Filter	OFF

Figure 7-23 Audio Settings

3. Configure the following settings.

Audio Encoding: G.722.1, G.711ulaw, G.711alaw, MP2L2, G.726 and PCM are selectable.

Audio Input: When an intercom is connected to the positioning system, you need to set this option to **Lineln**. When a microphone is connected to the positioning system, you need to set this option to **MicIn**.

Audio Stream Bitrate: When the Audio Encoding is selected as MP2L2, you can configure the Audio Stream Bitrate in the dropdown list. The greater the value is, the better the audio quality will be.

Sampling Rate: When the Audio Encoding is selected as MP2L2, you can configure the Sampling Rate in the dropdown list. The greater the value is, the better the audio quality will be.

Input Volume: Slid the **bar** to turn up/down the volume. The value ranges from 0 to 100.

Environmental Noise Filter: Select ON or OFF in the dropdown list to enable or disable the function. It's recommended to enable the function when the sampling rate is lower than 32kHz.

4. Click  to save the settings.

7.2.3 Configuring ROI Settings

Purpose:

ROI (Region of Interest) encoding is used to enhance the quality of images which are specified in advance. There are two different ROI methods: **Fixed Region** and **Dynamic Region**. When **Fixed Region** is enabled, image quality of ROI area will be enhanced and image quality of other areas will be reduced. When **Dynamic Region** is enabled, image quality of tracking target will be enhanced.



ROI function varies depending on the models of positioning system.

Steps:

1. Enter the ROI settings interface:

Configuration > Video/Audio > ROI

2. Select the channel No. from the drop-down list.

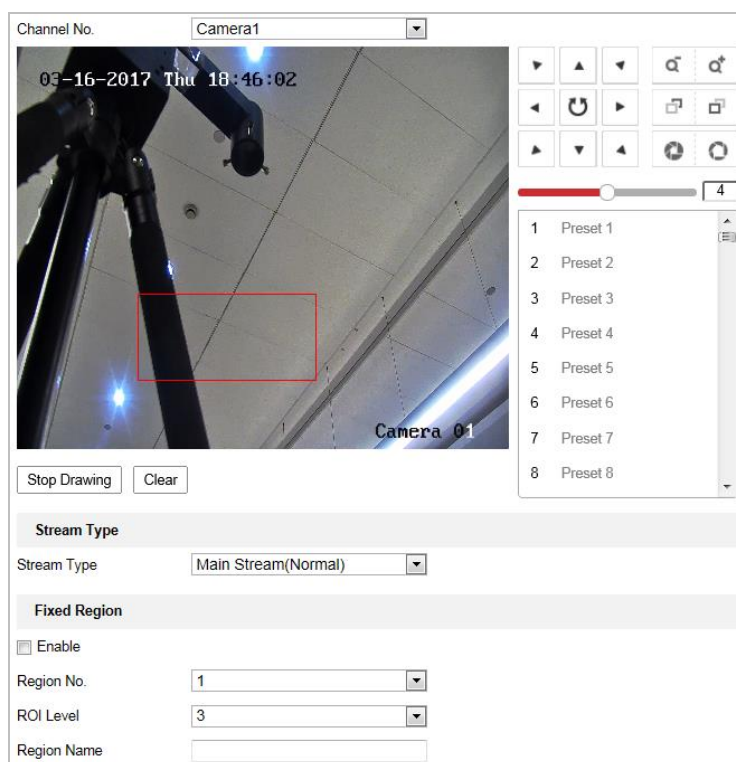

Figure 7-24 Region of Interest (1)

Stream Type	
Stream Type	Main Stream(Normal)
Fixed Region	
<input type="checkbox"/> Enable	
Region No.	1
ROI Level	3
Region Name	
Dynamic Region	
<input type="checkbox"/> Enable Face Tracking	
ROI Level	3
<input type="checkbox"/> Enable Target Tracking	
ROI Level	6

Figure 7-25 Region of Interest (2)

ROI for Fixed Region

Steps:

1. Check **Enable** checkbox to enable the **Fixed Region** function.
2. Select a stream type. You can set the ROI function for main stream, sub stream or third stream.
3. Click **Draw Area** and then click-and-drag the mouse to draw a red frame in the live view image. You can click **Clear** to clear it.



The number of areas supported in ROI function varies depending on the models of positioning system.

4. Select the **Region No.** from the dropdown list.
5. Adjust the **ROI level** from 1 to 6. The higher the value, the better image quality in the red frame.
6. Enter a **Region Name**.

ROI for Dynamic Region



1. Check **Enable Face Tracking** checkbox to enable face tracking, and the captured face picture is set as region of interest. Adjust the **ROI level** from 1 to 6.
2. Check **Enable Target Tracking** checkbox to enable target tracking, and the target is set as region of interest. Adjust the **ROI level** from 1 to 6.
3. Click **Save** to save the settings.



This function varies according to models.

7.3 PTZ Configuration



On the event configuration page, click  to show the PTZ control panel or click  to hide it.

Click the direction buttons to control the pan/tilt movements.

Click the zoom/iris/focus buttons to realize lens control.

The functions vary depending on the models of positioning system.

7.3.1 Configuring Basic PTZ Parameters

Purpose:

You can configure the basic PTZ parameters, including proportional pan, preset freezing, preset speed, etc.

1. Enter the Basic PTZ Parameter Configuration interface:

Configuration > PTZ > Basic Settings

Basic Parameter	
<input type="checkbox"/>	Enable Proportional Pan
<input type="checkbox"/>	Enable Preset Freezing
Preset Speed	4
Manual Control Speed	Compatible
Keyboard Control Speed	Medium
Auto Scan Speed	16
Zooming Speed	3
PTZ OSD	
Zoom Status	NO
PT Status	NO
Position Display Format	PT
Preset Status	2s
Power Off Memory	
Set Resume Time Point	30s
Linkage Control	
<input type="checkbox"/>	Synchronized Zoom
 Save	

Figure 7-26 Basic PTZ Configuration Interface

- Configure the following settings:

Basic Parameters: Enable/disable PTZ control, proportional pan and preset freezing, set the preset speed, keyboard control speed, and auto scan speed.

Proportional Pan: If you enable this function, the pan/tilt speeds change according to the amount of zoom. When there is a large amount of zoom, the pan/tilt speed will be slower for keeping the image from moving too fast on the live view image.

Preset Freezing: This function enables the live view to switch directly from one scene defined by a preset to another, without showing the middle areas between these two, to ensure the surveillance efficiency. It can also reduce the use of bandwidth in a digital network system.



Preset freezing function is invalid when you calling a pattern.

Preset Speed: You can set the speed of a defined preset from 1 to 8.

Manual Control Speed: The positioning system provides 5 control speed modes: Compatible, Pedestrian, Non-motor Vehicle, Motor Vehicle and Auto. Select it from the dropdown list.

Keyboard Control Speed: Define the speed of PTZ control by a keyboard as Low, Medium or High.

Auto Scan Speed: The scan speed can be set from level 1 to 40.

Max. Tilt-angle: Set the tilt-angle of the positioning system from the dropdown list.

Zooming Speed: The speed of zooming is adjustable.

PTZ OSD: Set the on-screen display duration of the PTZ status.

Zoom Status: Set the OSD duration of zooming status as 2 seconds, 5 seconds, 10 seconds, Always Close or Always Open.

PT Status: Set the azimuth angle display duration while panning and tilting as 2 seconds, 5 seconds, 10 seconds, Always Close or Always Open.

Position Display Format: Set the position display format as PT or Direction and the position parameter displays in corresponding format.

Preset Status: Set the preset name display duration while calling the preset as 2 seconds, 5 seconds, 10 seconds, Always Close or Always Open.

Power-off Memory: The positioning system can resume its previous PTZ status or actions after it restarted from a power-off. You can set the time point of which the positioning system resumes its PTZ status. You can set it to resume the status of 30 seconds, 60 seconds, 300 seconds or 600 seconds before power-off.

3. Click  to save the settings.

7.3.2 Configuring PTZ Limits

Purpose:

The positioning system can be programmed to move within the configurable PTZ limits (left/right, up/down).

Steps:

1. Enter the Limit configuration interface:
Configuration > PTZ > Limit

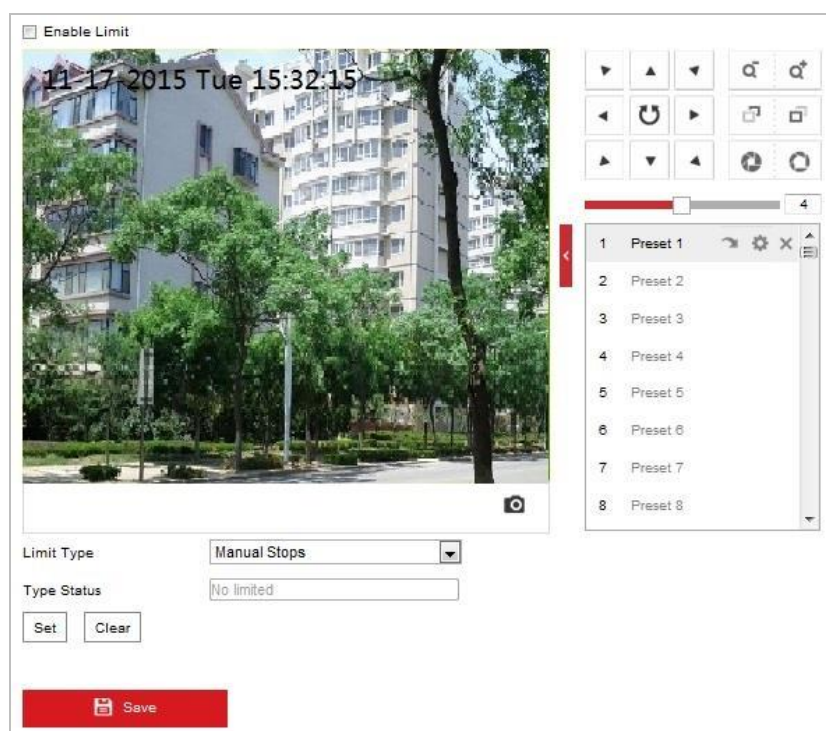

Figure 7-27 Configure the PTZ Limit

2. Click the checkbox of **Enable Limit** and choose the limit type as manual stops or scan stops.

Manual Stops:

When manual limit stops are set, you can operate the PTZ control panel manually only in the limited surveillance area.

Scan Stops:

When scan limit stops are set, the random scan, frame scan, auto scan, tilt scan, panorama scan is performed only in the limited surveillance area.



Manual Stops of **Limit Type** is prior to **Scan Stops**. When you set these two limit types at the same time, **Manual Stops** is valid and **Scan Stops** is invalid.

3. Click the PTZ control buttons to find the left/right/up/down limit stops; you can also call the defined presets and set them as the limits of the positioning system.
4. Click **Set** to save the limits or click **Clear** to clear the limits.

7.3.3 Configuring Park Actions

Purpose:

This feature allows the positioning system to start a predefined park action (scan, preset, pattern and etc.) automatically after a period of inactivity (park time).



Scheduled Tasks function is prior to **Park Action** function. When these two functions

are set at the same time, only the **Scheduled Tasks** function takes effect.

Pattern function varies depending on positioning system models.

Steps:

1. Enter the Park Action settings interface:

Configuration > PTZ > Park Action



Enable Park Action

Park Time s

Action Type

Action Type ID

Figure 7-28 Set the Park Action

2. Check the checkbox of **Enable Park Action**.
3. Set the **Park Time** as the inactivity time of the positioning system before it starts the park actions.
4. Choose **Action Type** the from the dropdown list.

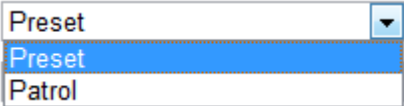

Preset

Preset

Patrol

Figure 7-29 Action Types

5. Select the **Action Type ID** from the dropdown list.
6. Click  Save to save the settings.

7.3.4 Configuring Privacy Mask

Purpose:

Privacy mask enables you to cover certain areas on the live video to prevent certain spots in the surveillance area from being live viewed and recorded.

Steps:

1. Enter the Privacy Mask settings interface:

Configuration > PTZ > Privacy Mask

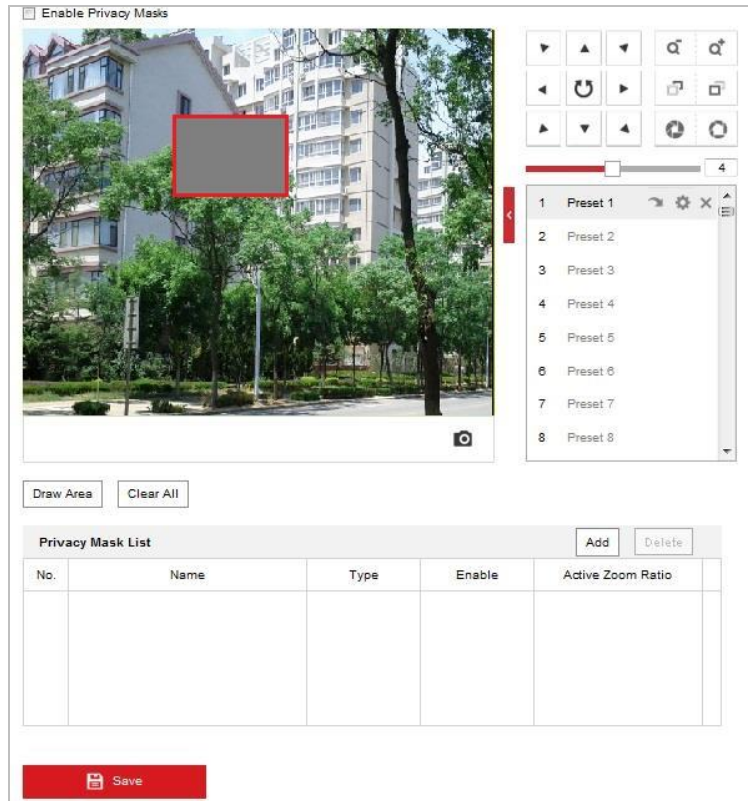

Figure 7-30 Draw the Privacy Mask

2. Click the PTZ control buttons to find the area you want to set the privacy mask.
3. Click **Draw Area**; click and drag the mouse in the live video window to draw the area.
4. You can drag the corners of the red rectangle area to draw a polygon mask.
5. Click **Stop Drawing** to finish drawing or click **Clear All** to clear all of the areas you set without saving them.
6. Click **Add** to save the privacy mask, and it will be listed in the **Privacy Mask List** area; set the value of **Active Zoom Ratio** on your demand, and then the mask will only appear when the zoom ratio is greater than the predefined value.

Privacy Mask List					Add	Delete
No.	Name	Type	Enable	Active Zoom Ratio		
1	Privacy Mask 1	gray	Yes	1		

Figure 7-31 Privacy Mask List

7. Check the checkbox of **Enable Privacy Mask** to enable this function.



You are allowed to draw up to 8 areas for the positioning system.

7.3.5 Configuring Scheduled Tasks

Purpose:

You can configure the network positioning system to perform a certain action automatically in a user-defined time period.

Steps:

1. Enter the Scheduled Task settings interface:

Configuration > PTZ > Scheduled Tasks

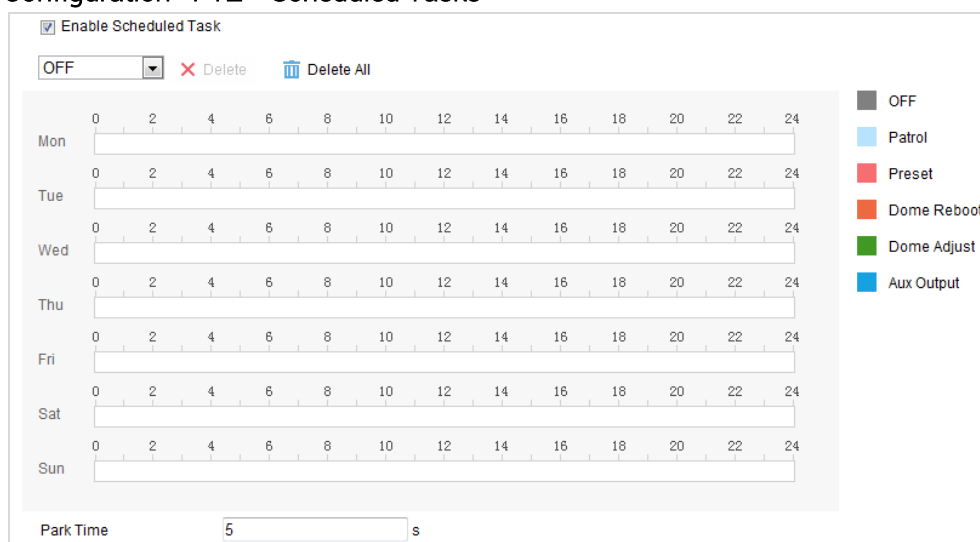

Figure 7-32 Configure Scheduled Tasks

2. Check the checkbox of **Enable Scheduled Task**.
3. Set the **Park Time**. You can set the park time (a period of inactivity) before the positioning system starts the scheduled tasks.
4. Select the task type from the dropdown list. You can choose scan, preset, pattern and etc.

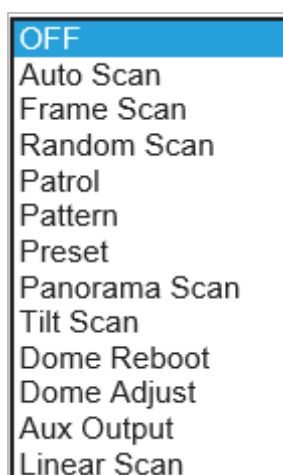



Figure 7-33 Task Types

5. Select the timeline of a certain day, click and drag the the mouse to set the recording schedule (the start time and end time of the recording task).

6. After you set the scheduled task, you can click  and copy the task to other days (optional).

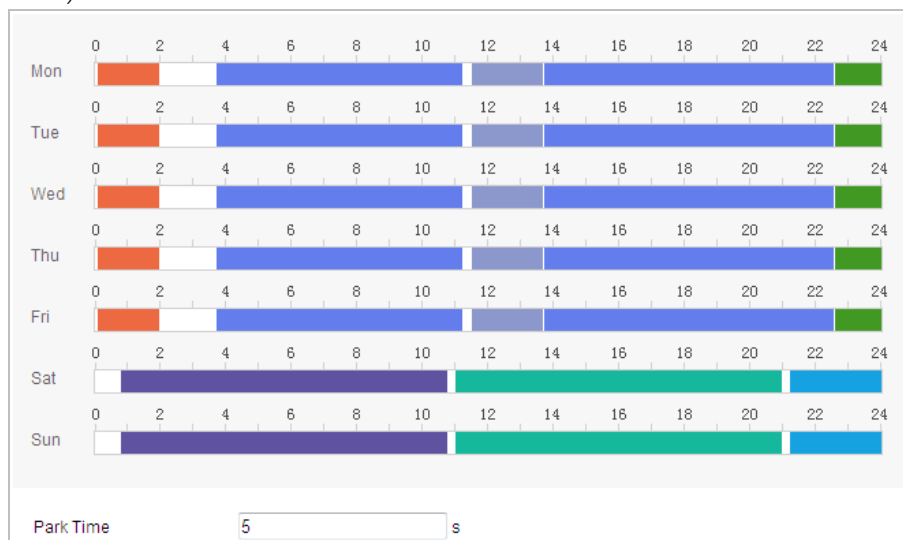

Figure 7-34 Edit the Schedule and Task Type



The time of each task cannot be overlapped. Up to 10 tasks can be configured for each day.

7. Click  to save the settings.

7.3.6 Clearing PTZ Configurations

Purpose:

You can clear PTZ configurations in this interface, including all presets, patrols, privacy masks, PTZ limits, scheduled tasks and park actions.



Pattern function varies depending on positioning system models.

Steps:

1. Enter the Clearing Configuration interface:
Configuration > PTZ > Clear Config
2. Check the checkbox of the items you want to clear.
3. Click  to clear the settings.

7.3.7 Prioritize PTZ

Steps:

1. Enter the Prioritize PTZ interface:
Configuration > PTZ > Prioritize PTZ.

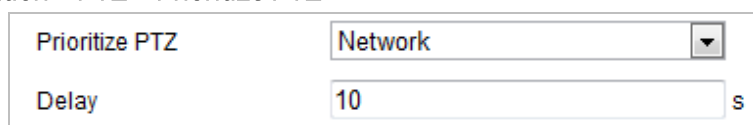

Prioritize PTZ	Network
Delay	10 s

Figure 7-35 Position Settings

2. Select Network or RS-485 from the dropdown list
3. Set the delay time (Range 2-200s).
4. Click  to save the settings.

7.3.8 Position and Vandal-Resistance Alarm Settings

Steps:

1. Enter the Position Settings interface:
Configuration > PTZ > Position Settings.



The actual interface may vary from model to model.

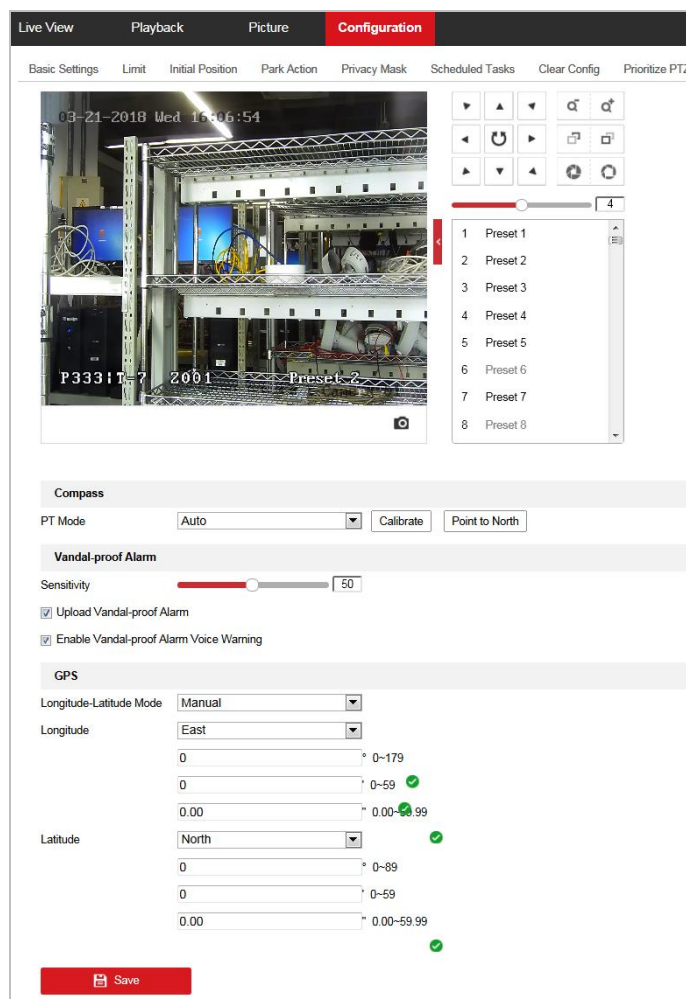



Figure 7-36 Position Settings

2. Set the vandal-resistance alarm.
 - (1) Slide the bar to adjust the sensitivity of vandal-resistance detection.
 - (2) Check the checkbox of **Upload Vandal-Resistance Alarm** to upload the vandal-resistance alarm.
 - (3) Check the checkbox of **Enable Vandal-Resistance Alarm Voice Warning** to enable the voice warning of vandal-resistance alarm.
3. Set GPS settings.
 - (4) Select Longitude-Latitude Mode as **Manual**.
 - (5) Select longitude and latitude as East or West according to the actual position.
 - (6) Enter the value of longitude and latitude in three textboxes.
4. Click  to save the settings.

7.3.9 Configuring Linear Scan

Steps:

1. Get to the linear scan interface:

Configuration > Advanced Configuration> PTZ > Linear Scan.

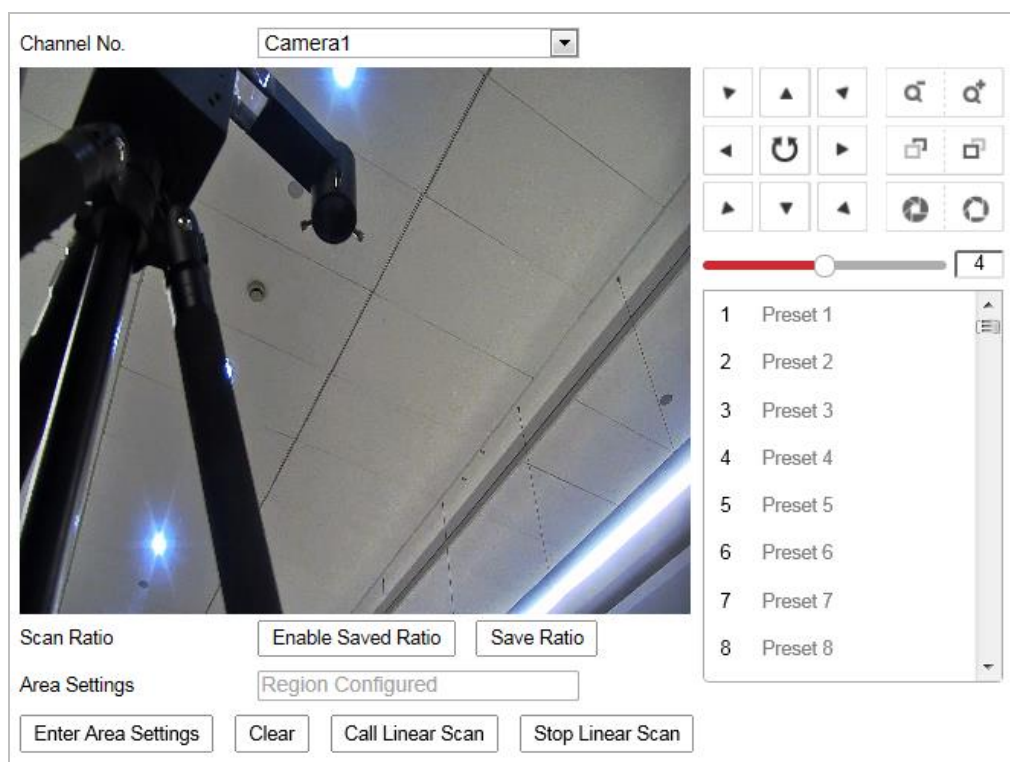



Figure 7-37 Linear Scan

2. Select Camera 1 or Camera 2 from the Channel No. list.
3. Zoom in and zoom out the camera to the appropriate zoom ratio.
4. Click **Save Ratio** to save the zoom ratio.
5. Optionally, you can click **Enable Saved Ratio** to set the camera to the saved zoom ratio.
6. Click **Set Scan Area** and set the left/right/up/down limits with the PTZ control panel and Iris+/- button.
7. Optionally, you can click **Clear** to delete the saved scan area.
8. Click **Save** to save the settings and the **Linear Scan Area** shows *Scan area saved*.
9. Click **Start Linear Scan** and **Stop Linear Scan** to start and stop the saved linear scan.

7.4 Configuring Image Settings



On the event configuration page, click  to show the PTZ control panel or click  to hide it.

Click the direction buttons to control the pan/tilt movements.

Click the zoom/iris/focus buttons to realize lens control.

The functions vary depending on the models of positioning system.

7.4.1 Configuring Display Settings

Purpose:

You can set the image quality of the positioning system, including brightness, contrast, saturation, sharpness, etc.



The parameters in **Display Settings** interface vary depending on the models of positioning system.

You can double click the live view to enter full screen mode and double click it again to exit.

Steps:

1. Enter the Display settings interface:

Configuration > Image > Display Settings

2. Select the channel No. from the dropdown list.

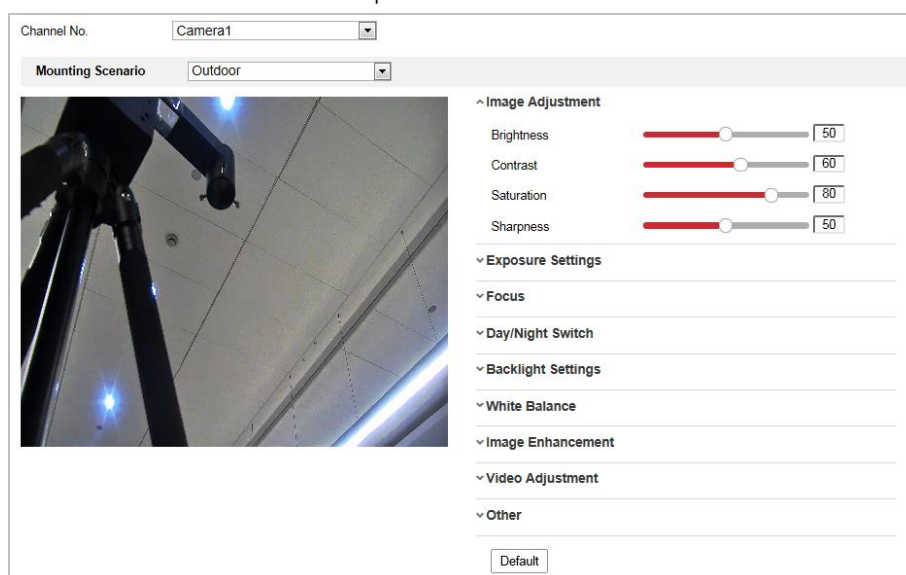

Figure 7-38 Display Settings

3. You can select the **Scene** in the dropdown list with different predefined image parameters.
4. Set the image parameters of the positioning system.

- **Setting the Channel Camera 1**

Image Adjustment

Brightness

This feature is used to adjust brightness of the image. The value ranges from 0 to 100.

Contrast

This feature enhances the difference in color and light between parts of an image. The value ranges from 0 to 100.

Saturation

This feature is used to adjust color saturation of the image. The value ranges from 0 to 100.

Sharpness

Sharpness function enhances the detail of the image by sharpening the edges in the image. The value ranges from 0 to 100.



The parameters vary depending on the models of positioning system.

Exposure Settings

Exposure Mode

The **Exposure Mode** can be set to **Auto**, **Iris Priority**, **Shutter Priority**, and **Manual**.

Auto:

The iris, shutter and gain values will be adjusted automatically according to the brightness of the environment.

Iris Priority:

The value of iris needs to be adjusted manually. The shutter and gain values will be adjusted automatically according to the brightness of the environment.

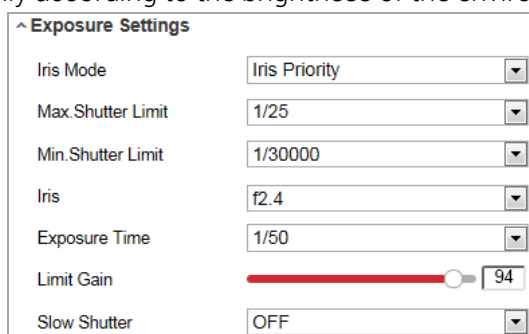

Figure 7-39 Manual Iris

Shutter Priority:

The value of shutter needs to be adjusted manually. The iris and gain values will be adjusted automatically according to the brightness of the environment.

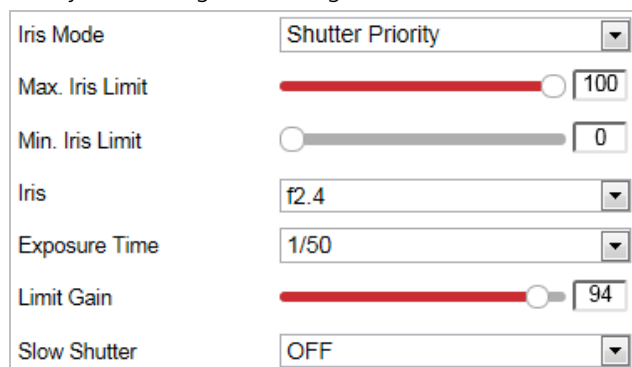

Figure 7-40 Manual Shutter

Manual:

In **Manual** mode, you can adjust the values of **Gain**, **Shutter**, **Iris** manually.

Limit Gain

This feature is used to adjust gain of the image. The value ranges from 0 to 100.

Slow Shutter

This function can be used in underexposure condition. It lengthens the shutter time to ensure full exposure.

Slow Shutter Level

When slow shutter is set as ON, you can select the slow shutter level from the dropdown list. The slow shutter lever can be set to **Slow Shutter*2**, ***3**, ***4**, ***6**, ***8**.

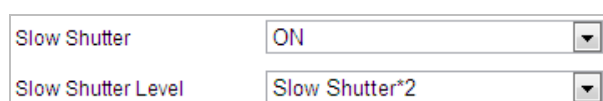

Figure 7-41 Slow Shutter



The parameters vary depending on the models of positioning system.

Focus Settings

Focus Mode

The **Focus Mode** can be set to **Auto**, **Manual**, **Semi-auto**.

Semi-auto:

The positioning system focuses automatically only once after panning, tilting and zooming.

Manual:

In **Manual** mode, you need to use   on the control panel to focus manually.

Min. Focus Distance

This function is used to limit the minimum focus distance.

Focus Speed:

This function is used to adjust the focus speed



The minimum focus value varies depending on the models of positioning system.

Day/Night Switch**Day/Night Switch**

The **Day/Night Switch** mode can be set to **Auto**, **Day**, **Night**, **Scheduled-Switch**. and **Triggered by Alarm Input**



This function varies depending on the models of positioning system.

Auto:

In **Auto** mode, the day mode and night mode can switch automatically according to the light condition of environment.

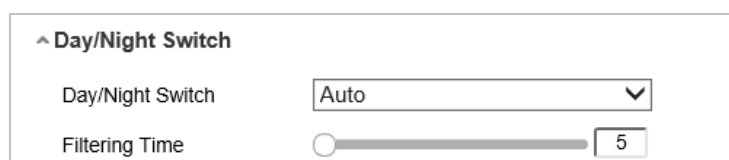

Figure 7-42 Auto Mode Sensitivity

Day:

In **Day** mode, the positioning system displays color image. It is used for normal lighting conditions.

Night:

In **Night** mode, the image is black and white. **Night** mode can increase the sensitivity in low light conditions.

Scheduled-Switch:

In **Schedule** mode, you can set the time schedule for day mode as shown in Figure 7-43. The rest time out of the schedule is for night mode.

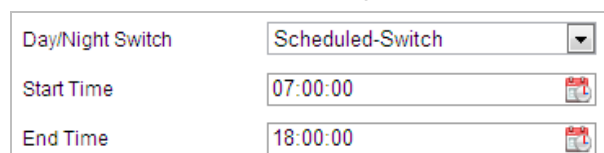

Figure 7-43 Day Night Schedule

Triggered by Alarm Input:

In **Triggered by Alarm Input** mode, you can set the triggered status to define the Day/Night mode.

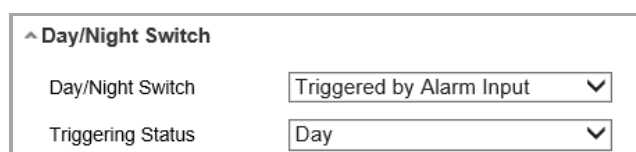

Figure 7-44 Triggered by Alarm Input

Backlight Settings

BLC (Back Light Compensation)

If there's a bright backlight, the subject in front of the backlight appears silhouetted or dark. Enabling **BLC**(back light compensation) function can correct the exposure of the subject. But the backlight environment is washed out to white.

WDR (Wide Dynamic Range)

The wide dynamic range (WDR) function helps the camera provide clear images even under back light circumstances. When there are both very bright and very dark areas simultaneously in the field of view, WDR balances the brightness level of the whole image and provide clear images with details.

You can enable or disable the WDR function as shown in Figure 7-45. The wide dynamic level ranges from 0 to 100.



Figure 7-45 WDR



This function varies depending on the models of positioning system.

HLC

HLC (High Light Compensation) makes the camera identify and suppress the strong light sources that usually flare across a scene. This makes it possible to see the detail of the image that would normally be hidden.

White Balance

The **White Balance** mode can be set to **Auto**, **MWB**, **Outdoor**, **Indoor**, **Fluorescent Lamp**, **Sodium Lamp** and **Auto-Tracking**.

Auto:

In **Auto** mode, the camera retains color balance automatically according to the current color temperature.

Manual White Balance:

In **MWB** mode, you can adjust the color temperature manually to meet your own demand as shown in Figure 7-46.

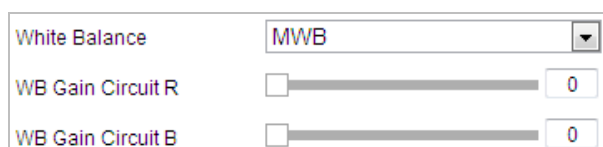

Figure 7-46 Manual White Balance

Outdoor

You can select this mode when the positioning system is installed in outdoor environment.

Indoor

You can select this mode when the positioning system is installed in indoor environment.

Fluorescent Lamp

You can select this mode when there are fluorescent lamps installed near the positioning system.

Sodium Lamp

You can select this mode when there are sodium lamps installed near the positioning system.

Auto-Tracking

In **Auto-Tracking** mode, white balance is continuously being adjusted in real-time according to the color temperature of the scene illumination.



This function varies depending on the models of positioning system.

Image Enhancement



This function varies depending on the models of positioning system.

3D Digital Noise Reduction

You can set **Digital Noise Reduction** function to **Normal** and adjust the **Noise Reduction Level** as shown in Figure 7-47. The level ranges from 0 to 100.

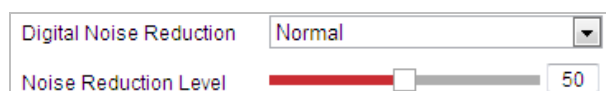

Figure 7-47 3D Digital Noise Reduction

If you are a professional technician, you can set it to **Expert Mode** then adjust **Space DNR Level** and **Time DNR Level**. The level ranges from 0 to 100.

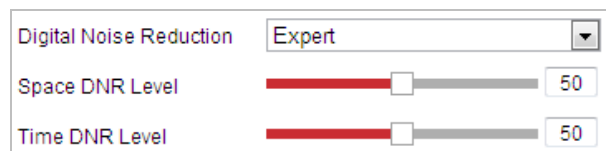

Figure 7-48 Expert Mode

Defog Mode

You can set the **Defog Mode** to ON or OFF as you need.



Figure 7-49 Defog Mode



When the defog mode is ON and the defog level is higher than 80, the optical defog function is activated automatically to enhance the defog effect.

Laser Compensation Region:

Choose the region of laser compensation according to the scene. Adaptive, Center, Full Screen are selectable..

Laser Level:

Choose the level of laser compensation.

OIS (Optical Image Stabilization)

You can set the OIS to OFF, Normal, or Expert as you need.

In Expert mode, you can set the OIS level and sensitivity as you need.

OIS	Expert	▼
OIS Level	Medium	▼
OIS Sensitivity	Medium	▼

Figure 7-50 Optical Image Stabilization

EIS (Electronic Image Stabilization)

You can set the EIS to ON or OFF as you need.

EIS	ON	▼
-----	----	---

Figure 7-51 Electronic Image Stabilization

Video Adjustment

Mirror

If you turn the MIRROR function on, the image will be flipped. It is like the image in the mirror. The flip direction can be set to OFF or CENTER.



This function varies depending on the models of positioning system.

Video Standard

You can set the Video Standard to 50hz(PAL) or 60hz(NTSC) according to the video system in your country.



This function varies depending on the models of positioning system.

Capture Mode

You can disable this function or select the capture mode from the list..



This function varies depending on the models of positioning system.

Other

Lens Initialization

The lens operates the movements for initialization when you check the check box of **Lens Initialization**.

Zoom Limit

You can set **Zoom Limit** value to limit the maximum value of zooming. The value can be selected from the list.

Local Output

You can enable or disable the video output through the BNC interface on your demand.



The functions vary depending on the models of positioning system.

Setting the Channel Camera 2

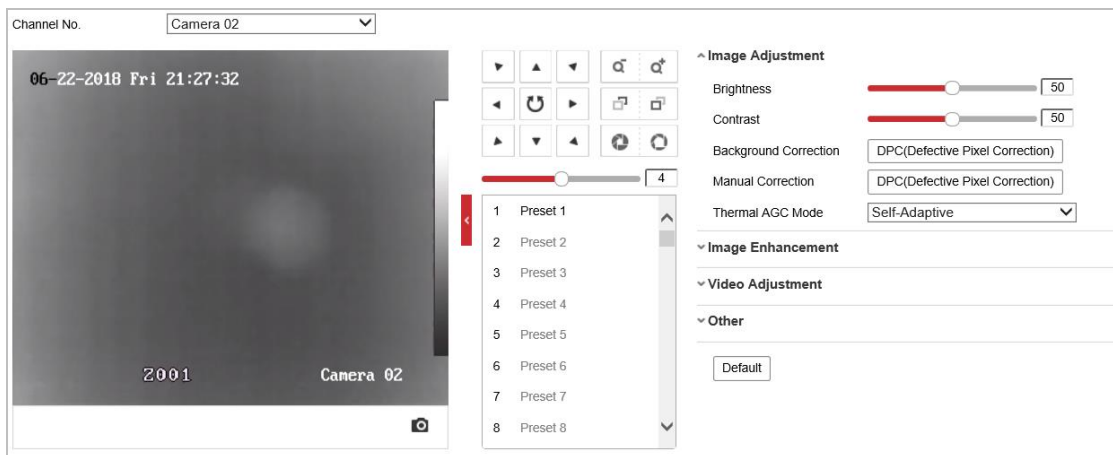

Figure 7-52 Camera No. 2 Image Settings

Image Adjustment

Brightness

This feature is used to adjust brightness of the image. The value ranges from 0 to 100.

Contrast

This feature enhances the difference in color and light between parts of an image. The value ranges from 0 to 100.

Background Correction

Fully cover the lens with an object (lens cover is recommended) and click the **Background Correction** button, and then the speed dome adjusts the image according to the current environment.

Manual Correction

Click the **Manual Correction** button and then the speed dome adjusts the image according to the temperature of the camera itself.

Thermal AGC

Choose the AGC mode according to different scenes to balance and improve the image quality.

- **Histogram:** Choose for scene with obvious WDR and high temperature difference, can improve image contrast and enhance image. E.g. the scene contains both indoor and outdoor scenes.
- **Linear:** Choose for scene with low temperature difference and the target is not obvious, can improve image contrast and enhance image. E.g. the bird in forest.
- **Self-Adaptive:** Choose AGC mode automatically according to current scene.

Image Enhancement

Digital Noise Reduction:

DNR reduces the noise in the video stream. OFF, Normal Mode and Expert Mode are selectable.

OFF: DNR is disabled.

Normal Mode: Set the DNR level from 0~ 100, and the default value is 50.

Expert Mode: Set the DNR level from both space DNR level [0~100] and time DNR level [0~100] in Expert Mode.

Palettes

The palettes allow you to select the desired colors. white hot, black hot, fusion 1, rainbow, fusion 2, ironbow 1, ironbow2, sepia, color 1, color 2, ice fire, rain, red hot, and green hot are selectable.

DDE

The DDE (Digital Detail Enhancement) can adjust the details of the image. And you can set it to OFF or Normal mode. And **DDE Level** can be adjust from 1 to 100 when in normal mode.

Brightness Sudden Change Suppression

When the brightness of target and the background is hugely different (the temperature difference of target and background is huge), the system reduces the difference for viewing.

Video Adjustment

Mirror

If you turn the **Mirror** function on, the image will be flipped. You can set the mirror direction to Center or disable it.



This function varies depending on the models of positioning system.

Video Standard

The **Video Standard** is configurable.



This function varies depending on the models of positioning system.

Capture Mode:

You can set the **Capture Mode** to OFF and 384*288@25fps.

Digital Zoom

The digital zoom is available for the thermal sensor, there are x2 and X4 selectable.



This function varies depending on the models of positioning system.

7.4.2 Configuring OSD Settings

Purpose:

The positioning system supports following on screen displays:

Time: Supports for time display.

Camera Name: Identifies the name of positioning system.

You can customize the on screen display of time.

Steps:

1. Enter the OSD settings interface:
Configuration > Image > OSD Settings
2. Select the channel No..

Channel No.

Display Name

Display Date

Display Week

Camera Name

Time Format

Date Format

Text OverLay

1

2

3

4

5

6

7

8

Display Mode

OSD Size

Font Color

Figure 7-53 OSD Settings

3. Check the corresponding checkbox to select the display of positioning system name,

- date or week if required.
4. Edit the positioning system name in the text field of **Camera Name**.
 5. Select from the dropdown list to set the time format, date format, display mode, OSD size and Font color.
 6. You can use the mouse to click and drag the text frame **IPdome** in the live view window to adjust the OSD position.



Figure 7-54 Adjust OSD Location

7. Click  to activate above settings.

7.4.3 Configuring Text Overlay Settings

Purpose:

You can customize the text overlay.

Steps:

1. Enter the Text Overlay settings interface:
Configuration > Image > OSD Settings
2. Check the checkbox in front of textbox to enable the on-screen display.
3. Input the characters in the textbox.
4. Use the mouse to click and drag the red text frame **Text** in the live view window to adjust the text overlay position.
5. Click  to save the settings.

7.4.4 Configuring DPC Settings

DPC (Defective Pixel Correction) refers to the function that the camera can correct the defective pixels on the LCD which are not performing as expected.

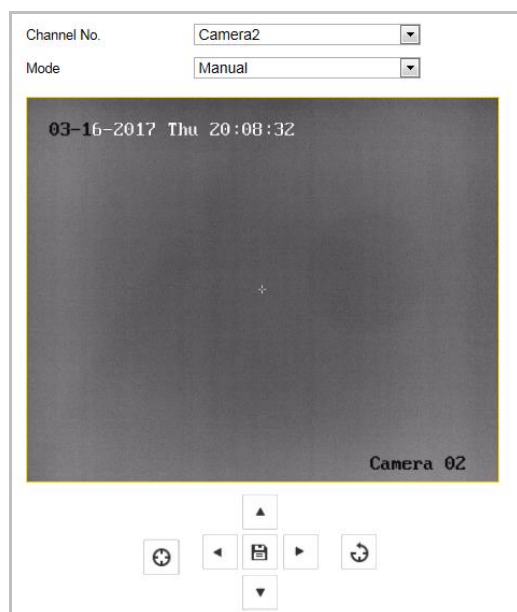



Figure 7-55 Defective Pixel Correction



Auto DPC Correction

Steps:

1. Select Auto from the modes.
2. Click  to start correction.

Manual DPC Correction

Steps:

1. Select Manual from the modes.
2. Point to the defective pixel, and click  to adjust the position.
3. Click  to start correction.
4. (Optional) Click  to cancel the correction.



This function varies depending on the models of positioning system.

7.4.5 Picture in Picture

Before you start:

Enter **Configuration > System > System Maintenance > VCA Resource Type** to select Picture in Picture as VCA Resource Type.

Purpose:

The system plays the live view of thermal channel and optical channel at the same time.

Steps:

1. Select the channel No. from the list.



Select Camera 1 and the device plays the live view of Camera 2 inside the live view of Camera 1.

2. Check the checkbox of **Enable**.

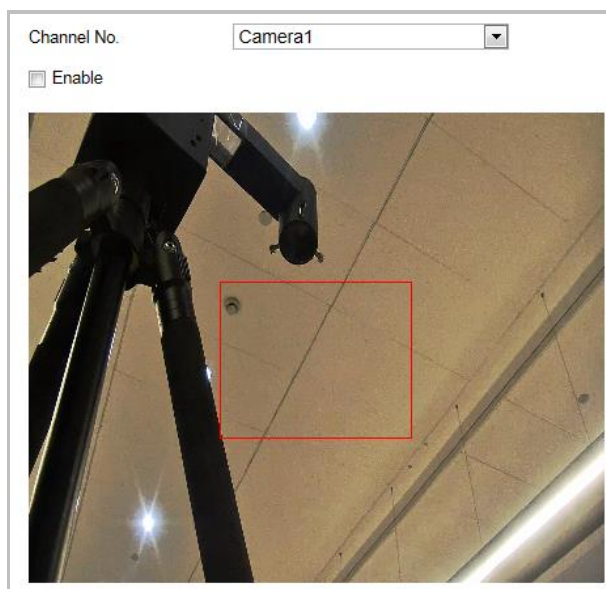

Figure 7-56 Picture in Picture

3. Drag the red frame to adjust the picture in picture site.
4. Click **Save** to activate above settings.

7.5 Configuring System Settings

7.5.1 System Settings

Viewing Basic Information

Enter the Device Information interface:

Configuration > System > System Settings > Basic Information

In the **Basic Information** interface, you can edit the Device Name and Device No..

Other information of the network zoom camera, such as Model, Serial No., Firmware Version, Encoding Version, Web Version, Plugin Version, Number of Channels, Number of HDDs, Number of Alarm Input and Number of Alarm Output are displayed. The information cannot be changed in this menu. It is the reference for maintenance or modification in future.

Device Name	IP DOME
Device No.	88
Model	
Serial No.	
Firmware Version	
Encoding Version	
Web Version	
Plugin Version	
Number of Channels	
Number of HDDs	
Number of Alarm Input	
Number of Alarm Output	

Figure 7-57 Device Information

Time Settings

Purpose:

You can follow the instructions in this section to configure the time which can be displayed on the video. There are Time Zone, Time Synchronization, Daylight Saving Time (DST) functions for setting the time. Time Synchronization consists of auto mode by Network Time Protocol (NTP) server and manual mode.

Enter the Time Settings interface:

Configuration > System > System Settings > Time Settings

Basic Information **Time Settings** DST RS485

Time Zone: (GMT+08:00) Beijing, Urumqi, Singapore

NTP

NTP

Server Address: time.windows.com

NTP Port: 123

Interval: 1440 min

Test

Manual Time Sync.

Manual Time Sync.

Device Time: 2015-11-17T15:39:53

Set Time: 2015-11-17T15:39:20 Sync. with computer time

Save

Figure 7-58 Time Settings

Configuring Time Synchronization by NTP Server

Steps:

- (1) Check the radio button to enable the **NTP** function.
- (2) Configure the following settings:
 - Server Address:** IP address of NTP server.
 - NTP Port:** Port of NTP server.
 - Interval:** The time interval between the two synchronizing actions by NTP server. It can be set from 1 to 10080 minutes.

Figure 7-59 Time Sync by NTP Server



You can click  to make sure that the NTP server is connected.



If the positioning system is connected to a public network, you should use a NTP server that has a time synchronization function, such as the server at the National Time Center (IP Address: 210.72.145.44). If the positioning system is set in a customized network, NTP software can be used to establish a NTP server for time synchronization.

Configuring Time Synchronization Manually

Steps:

- (1) Check the **Manual Time Sync** radio button.
- (2) Click  to set the system time from the pop-up calendar.
- (3) Click  to save the settings.



You can also check the **Sync with local time** checkbox to synchronize the time of the positioning system with the time of your computer.

Figure 7-60 Time Sync Manually

Select the Time Zone

Purpose:

When the positioning system is taken to another time zone, you can use the **Time Zone** function to adjust the time. The time will be adjusted according to the original time and the time difference between the two time zones.

From the **Time Zone** dropdown menu as shown in Figure 7-61, select the Time Zone in which the positioning system locates.

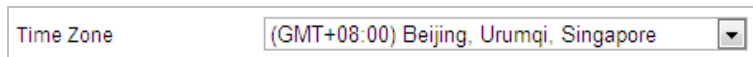

Figure 7-61 Time Zone Settings

Configuring DST (Daylight Saving Time)

Purpose:

If there is the habit of adjusting clocks forward in your country in certain time period of a year, you can turn this function on. The time will be adjusted automatically when the Daylight Saving Time (DST) comes.

Steps:

1. Enter the **DST** interface by **Configuration > Advanced Configuration > System > DST**

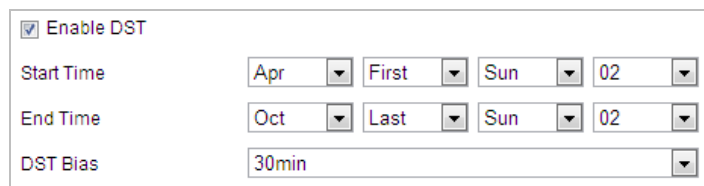



Figure 7-62 DST Settings

2. Check **Enable DST** to enable the DST function.
3. Set the date of the DST period.
4. Click  to save the settings.

Configuring RS-485

Purpose:

The RS-485 serial port is used to control the PTZ of the camera. The configuring of the PTZ parameters should be done before you control the PTZ unit.

Steps:

1. Enter RS-485 Port Setting interface:
Configuration > Advanced Configuration > System > RS-485

Basic Information	Time Settings	DST	RS485
Baud Rate	9600		
Data Bit	8		
Stop Bit	1		
Parity	None		
Flow Ctrl	None		
PTZ Protocol	PELCO-D		
PTZ Address	0		

Figure 7-63 RS-485 Settings

2. Set the RS-485 parameters and click  to save the settings.



The Baud rate, PTZ Protocol and PTZ Address parameters of the positioning system should be exactly the same as those of the control device.

7.5.2 Maintenance

Upgrade & Maintenance

Rebooting the Positioning system

Steps:

1. Enter the Maintenance interface:
2. **Configuration > System > Maintenance > Upgrade & Maintenance:**
3. Click **Reboot** to reboot the network positioning system.

Restoring Default Settings

Steps:

1. Enter the Maintenance interface:
Configuration > System > Maintenance > Upgrade & Maintenance:
2. Click **Restore** or **Default** to restore the default settings.



Clicking **Default** to restores all the parameters to default settings including the IP address and user information. Please use this button with caution.

Default	
Restore	Reset all the parameters, except the IP parameters and user information, to the default settings.
Default	Restore all parameters to default settings.

Figure 7-64 Restore Default Settings

Information Export

Steps:

1. Enter the Maintenance interface:
Configuration > System > Maintenance > Upgrade & Maintenance:
2. Click **Device Parameters** and input the encryption password twice to encrypt the config file.



Figure 7-65 Encryption Configuration File

3. Select the path to export the current configuration file. You can configure the other cameras with the file.
4. Click Diagnose Information to view the device error information.

Importing/Exporting Configuration File

Steps:

1. Enter the Maintenance interface:
Configuration > System > Maintenance > Upgrade & Maintenance:
2. Click **Browse** to select the local configuration file and then click **Import** to start importing configuration file.



You need to reboot the positioning system after importing configuration file.

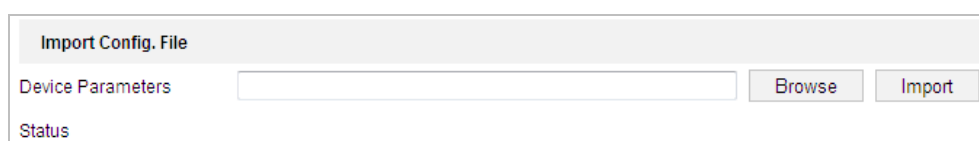

Figure 7-66 Import Configuration File

3. If the configuration file is encrypted, enter the password.

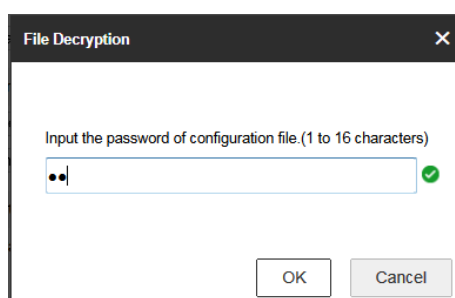

Figure 7-67 File Decryption

Upgrading the System

Steps:

1. Enter the Maintenance interface:
Configuration >System > Maintenance > Upgrade & Maintenance
2. Select Firmware or Firmware Directory.
 - Firmware:** when you select **Firmware**, you need to find the firmware in your computer to upgrade the device.
 - Firmware Directory:** You need to find the directory where the firmware locates. The device can find the firmware in the directory automatically.
3. Click to select the local upgrade file and then click to start remote upgrade.



The upgrading process will take 1 to 10 minutes. Please don't disconnect power of the positioning system during the process. The positioning system reboots automatically after upgrading.



Figure 7-68 Remote Upgrade

Log Searching

Purpose:

The operation, alarm, exception and information of the positioning system can be stored in log files. You can also export the log files on your demand.

Before you start:

Please configure network storage for the positioning system or insert a memory card in the positioning system.

Steps:

1. Enter the Log interface:
Configuration >System > Maintenance > Log

Upgrade & Maintenance **Log** System Service

Major Type: All Types Minor Type: All Types

Start Time: 2015-08-11 00:00:00 End Time: 2015-08-11 23:59:59 Search

Log List Export

No.	Time	Major Type	Minor Type	Channel No.	Local/Remote User	Remote Host IP
Total 0 Items << < 0/0 > >>						

Figure 7-69 Log Searching Interface

- Set the log search conditions to specify the search, including the Major Type, Minor Type, Start Time and End Time as shown in Figure 7-69.
- Click **Search** to search log files. The matched log files will be displayed on the **Log** interface.
- To export the log files, click **Save Log** to save the log files in your computer.

System Service

Steps:

- Enter the interface of configuring the remote connection:
Configuration > System > Maintenance > System Service
- Check the checkbox of **Enable Supplement Light** on your demand.
- Check the checkbox of **Enable Automatic De-icing** on your demand.



The de-icing heater is only supported under POE+, 24VAC, or 12VDC power supply.

- Select the power saving mode between manual and scheduled.

Power Saving Mode: Select power saving mode as manual, and you can turn on and off the power saving function. Select power saving mode as scheduled, you can customize the schedule for enabling the automatic de-icing function.

Electric Current Limit: The function is used to set the electrical current for device. You can select electricity capacity in the dropdown list as you desired. For example, if you choose 3/4 Electricity Capacity, then 75% electric current output to device for power supply.

Hardware

Enable Supplement Light

Enable Automatic De-Icing The de-icing heater is only supported under POE+, 24VAC, or 12VDC power supply.

Power Saving Control

Manual Control

Electric Current Limit

Hardware

Enable Supplement Light

Enable Automatic De-Icing The de-icing heater is only supported under POE+, 24VAC, or 12VDC power supply.

Power Saving Control

Start Time

End Time

Electric Current Limit

Figure 7-70 Hardware Settings

5. Click  button to activate the settings.

VCA Resource Type

Purpose:

Before using the VCA function of the camera, you should select the VCA resource type first. To use Temperature Measurement and Behavior Analysis, select Temperature Measurement and Behavior Analysis. To use Temperature Measurement and Behavior Analysis and Fire Detection function, select Temperature Measurement and Behavior Analysis and Fire Detection.

Steps:

1. Enter the VCA Resource Type interface:
Configuration > Advanced Configuration > System > VCA Resource Type

VCA Resource Configuration

Temperature Measurement+Behavior Analysis

Temperature Measurement+Fire Detection

Figure 7-71 VCA Information

2. Check the checkbox to enable the VCA resource type.
3. The system reboots and the selected VCA resource will be enabled.



Once you select any of the resources, the other VCA rules cannot be enabled.

7.5.3 Security

Configuring Authentication Security

Purpose:

You can specifically secure the stream data of live view.

Steps:

1. Enter the Authentication interface:
Configuration > System > Security > Authentication
2. Set the authentication mode for each authentication type.
RTSP Authentication: Select the authentication mode as basic or disable in the dropdown list to enable or disable the RTSP authentication.
3. Click  to save the settings.

Configuring IP Address Filter

Purpose:

With this function on, the camera allows certain IP addresses whether to log in or not.

Steps:

1. Enter IP Address Filter interface:
Configuration > System > Security > IP Address Filter

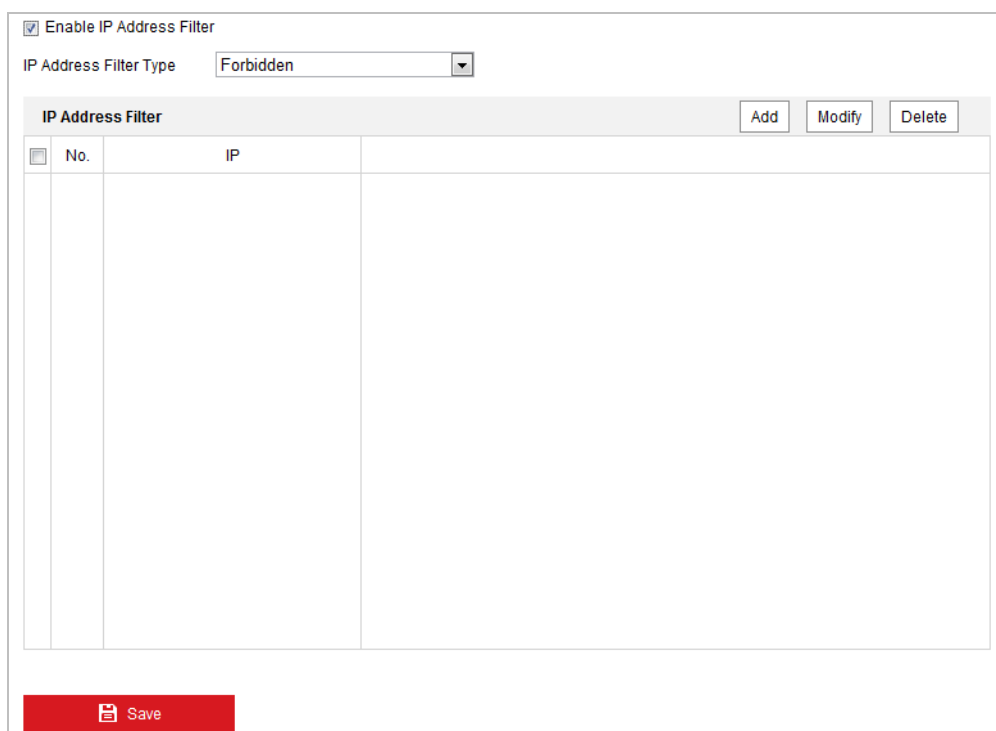

The screenshot shows a configuration window for IP Address Filtering. At the top, there is a checked checkbox labeled "Enable IP Address Filter". Below it, a dropdown menu for "IP Address Filter Type" is set to "Forbidden". A table titled "IP Address Filter" is present, with columns for "No.", "IP", and an empty column. Above the table are "Add", "Modify", and "Delete" buttons. A red "Save" button is located at the bottom of the window.

No.	IP	
-----	----	--

Figure 7-72 IP Address Filter

2. Check the checkbox of **Enable IP Address Filter**.
3. Select the type of IP Address Filter in the dropdown list, Forbidden and Allowed are selectable.
4. Set the IP Address Filter list.

Add an IP Address

Steps:

- (1) Click **Add** to add an IP.
- (2) Input the IP Address.



The dialog box titled "Add IP Address" has a close button (X) in the top right corner. It contains a text input field labeled "IP Address" with the value "172.6.23.2" and a green checkmark icon to its right. Below the input field are "OK" and "Cancel" buttons.

Figure 7-73 Add an IP

- (3) Click **OK** to finish adding.

Modify an IP Address

Steps:

- (1) Left-click an IP address from filter list and click **Modify**.
- (2) Modify the IP address in the text field.

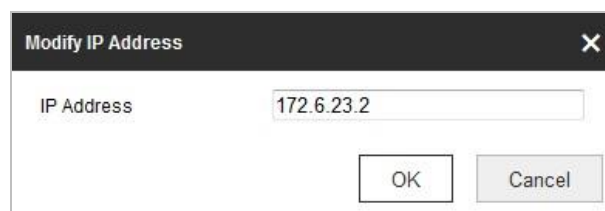

Figure 7-74 Modify an IP

- (3) Click **OK** to finish modifying.

Delete an IP Address

Left-click an IP address from filter list and click **Delete**.

Delete all IP Addresses

Click **Clear** to delete all the IP addresses.

5. Click  to save the settings.

Configure Security Service Settings

Steps:

1. Enter the Security Service interface:
Configuration > System > Security > Security Service
2. Check the checkbox to enable the SSH function.
Enable SSH: Enabling SSH (Secure Shell) function is to encrypt and compress the data and to reduce the transmission time.
3. Check the checkbox to enable the Illegal Login Lock function.
Illegal Login Lock: Enabling illegal login lock function is to automatically lock the device IP after the admin user performing 7 failed password attempts (5 attempts for the user/operator).
4. Click  to save the settings.

7.5.4 User Management

Enter the User Management interface:

Configuration > System > User Management

The **admin** user has access to create, modify or delete other accounts. Up to 32 user accounts can be created.

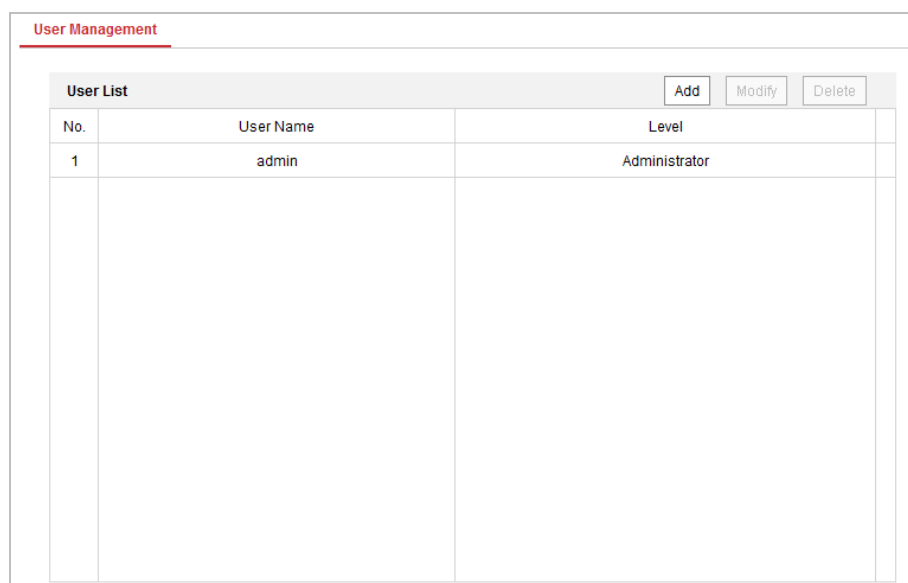

User Management		
User List		
No.	User Name	Level
1	admin	Administrator

Figure 7-75 User Information

Add a User

Steps:

1. Click  to add a user.
2. Input the new **User Name**, select **Level** and input **Password**.



For your privacy and to better protect your system against security risks, we strongly recommend the use of strong passwords for all functions and network devices. The password should be something of your own choosing (Using a minimum of 8 characters, including at least three of the following categories: upper case letters, lower case letters, numbers, and special characters.) in order to increase the security of your product.

Proper configuration of all passwords and other security settings is the responsibility of the installer and/or end-user.



The level indicates the permissions you give to the user. You can define the user as **Operator** or **User**.

3. In the **Basic Permission** field and **Camera Configuration** field, you can check or uncheck the permissions for the new user.
4. Click  to finish the user addition.

Add user

User Name: user1 ✓

Level: Operator

Password: ●●●●●●●● ✓
Strong

Valid password range [8-16]. You can use a combination of numbers, lowercase, uppercase and special character for your password with at least two kinds of them contained.

Confirm: ●●●●●●●● ✓

Select All

Remote: Parameters Settings

Remote: Log Search / Interrogate Wo...

Remote: Upgrade / Format

Remote: Two-way Audio

Remote: Shutdown / Reboot

Remote: Notify Surveillance Center / ...

Remote: Video Output Control

Remote: Serial Port Control

Remote: Live View

Remote: Manual Record

Remote: PTZ Control



Remote: Playback

OK Cancel

Figure 7-76 Add a User

Modify a User

Steps:

1. Left-click to select the user from the list and click .
2. Modify the **User Name**, **Level** or **Password**.
3. In the **Basic Permission** field and **Camera Configuration** field, you can check or uncheck the permissions.
4. Click  to finish the user modification.

Modify user

User Name: user1

Level: Operator

Password: ●●●●●●

Valid password range [8-16]. You can use a combination of numbers, lowercase, uppercase and special character for your password with at least two kinds of them contained.

Confirm: ●●●●●●

- Select All
- Remote: Parameters Settings
- Remote: Log Search / Interrogate Wo...
- Remote: Upgrade / Format
- Remote: Two-way Audio
- Remote: Shutdown / Reboot
- Remote: Notify Surveillance Center /...
- Remote: Video Output Control
- Remote: Serial Port Control
- Remote: Live View
- Remote: Manual Record
- Remote: PTZ Control
- Remote: Playback

OK Cancel

Figure 7-77 Modify a User

Delete a User

Steps:

1. Left-click the user name you want to delete and click .
2. Click on the pop-up dialogue box to delete the user.

Online Users

Enter the Online Users configuration interface:

Configuration > System > User Management > Online Users

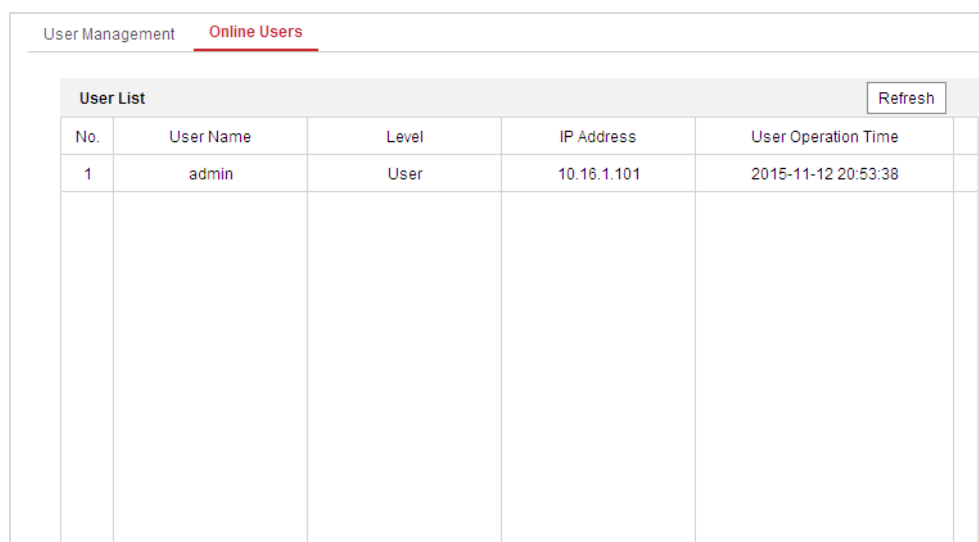

The screenshot shows a web interface for 'User Management' with a sub-tab for 'Online Users'. Below the navigation is a 'User List' table with a 'Refresh' button. The table has five columns: 'No.', 'User Name', 'Level', 'IP Address', and 'User Operation Time'. One row is visible with the following data: No. 1, User Name 'admin', Level 'User', IP Address '10.16.1.101', and User Operation Time '2015-11-12 20:53:38'.

User List					Refresh
No.	User Name	Level	IP Address	User Operation Time	
1	admin	User	10.16.1.101	2015-11-12 20:53:38	

Figure 7-78 Online Users

You can see the current users who are visiting the device through this interface. User information, such as user name, level, IP address, and operation time, is displayed in the User List. Click **Refresh** to refresh the list.

Appendix

SADP Software Introduction

Description of SADP

SADP (Search Active Devices Protocol) is a kind of user-friendly and installation-free online device search tool. It searches the active online devices within your subnet and displays the information of the devices. You can also modify the basic network information of the devices using this software.

Search active devices online

Search online devices automatically

After launch the SADP software, it automatically searches the online devices every 15 seconds from the subnet where your computer locates. It displays the total number and information of the searched devices in the Online Devices interface. Device information including the device type, IP address and port number, etc. will be displayed.

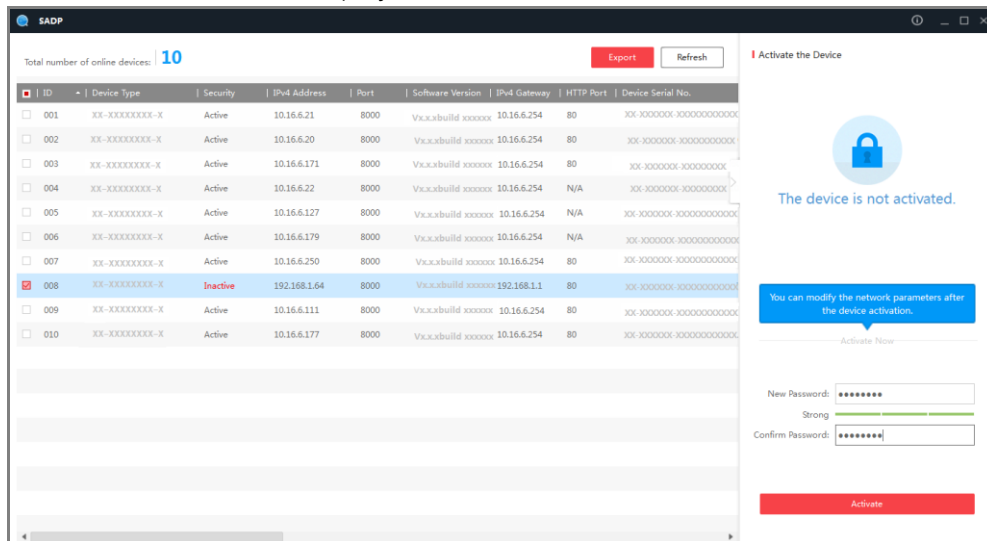
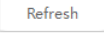

Figure A.1.1 Searching Online Devices





Device can be searched and displayed in the list in 15 seconds after it went online; it will be removed from the list in 45 seconds after it went offline.

Search online devices manually

You can also click  to refresh the online device list manually. The newly searched devices will be added to the list.



You can click  or  on each column heading to order the information; you

can click  to expand the device table and hide the network parameter panel on the right side, or click  to show the network parameter panel.

Modify network parameters

Steps:

1. Select the device to be modified in the device list and the network parameters of the device will be displayed in the **Modify Network Parameters** panel on the right side.
2. Edit the modifiable network parameters, e.g. IP address and port number.
3. Enter the password of the admin account of the device in the **Password** field and click

 to save the changes.



For your privacy and to better protect your system against security risks, we strongly recommend the use of strong passwords for all functions and network devices. The password should be something of your own choosing (using a minimum of 8 characters, including upper case letters, lower case letters, numbers and special characters) in order to increase the security of your product.

Proper configuration of all passwords and other security settings is the responsibility of the installer and/or end-user.



Figure A.1.2 Modify Network Parameters



See Far, Go Further